

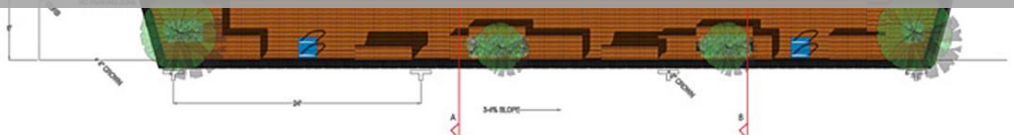

CITY OF  
SACRAMENTO

# Sacramento Parklet Program Manual



Questions? Please refer to Sacramento's Parklet Program website: [www.sacparklet.org](http://www.sacparklet.org) or email

[sacparkletprogram@cityofsacramento.org](mailto:sacparkletprogram@cityofsacramento.org)



*The City of Sacramento Parklets Program Manual was created by the City of Sacramento Department of Public Works in close collaboration with the City of Sacramento Community Development Department.*

City of  
**SACRAMENTO**  
Department of Public Works

Department of Public Works  
300 Richards Blvd., 2<sup>nd</sup> Floor  
Sacramento, Ca 95811

# CITY OF SACRAMENTO

## Parklet

# Program Manual

### ABOUT THIS MANUAL

*This manual is an overview of the goals, policies, processes, procedures and guidelines for creating a parklet in Sacramento. Applicants and designers in the City of Sacramento are strongly encouraged to read this Manual in its entirety when they are first thinking about proposing a parklet and utilize it as a reference as you may be selected to continue through the process of providing a parklet for Sacramento. Understanding what the program is trying to achieve and the process and regulations for a successful parklet may reduce the time it takes to receive a permit, and will likely result in a superior parklet design.*

*City of Sacramento values and appreciates your willingness to devote your time, creativity, and resources to creating a parklet in your neighborhood. We look forward to collaborating with you on your parklet.*

**What can I do to enhance the right-of-way in front of my business?**



**Envision...**



**Apply...**

**Partner...**

**Design...**



**Build...**



**Enjoy...**

**Maintain...**

## Table of Contents

(I) Program Overview .....	7
(II) Stakeholder Roles .....	8
Application Intake and Design Review: .....	8
Permitting and Inspection: .....	8
Design, Permit fees, Capital Cost, Liability and Maintenance: .....	8
Step 1: Applicant Submits Parking Proposal. ....	10
Public Outreach: .....	10
Step 2: Initial Review by Public Works “Development Engineering”. ....	10
Step 3: Committee Reviews Proposal. ....	11
Step 4: 10 Day Public Notice .....	11
Step 4.1: Potential Review Committee: .....	11
Step 5: Design Development With Public Works Development Engineering: .....	12
Applicant Submits Construction Documents: .....	12
Interdepartmental Final Review and Approval: .....	12
Permit Issuance: .....	12
Step 6: Fabrication and Installation .....	13
Construction: .....	13
Step 7: Post Construction .....	14
Important Consideration: .....	15
Parklets are Public: .....	15
Designing for the urban landscape: .....	15
Design is iterative: .....	15
Your patience is appreciated: .....	15
(III) Steps to Parklet .....	16
Step 1: Parklet Location Criteria .....	17
Step 2: Creating an Initial Site Plan .....	21
Step 3: Building Neighborhood Support .....	24
Step 4: Initial Proposal Review .....	25
Step 5: Design Development .....	27
General Guidelines .....	27

Inclusive Design (ADA Compliance) .....	27
The Platform .....	28
The Enclosure .....	30
Amenities .....	32
Bicycle Parking .....	33
Sustainable Design & Construction .....	34
Final Construction Document Package .....	35
Interdepartmental Review and Approval .....	37
Parklet Fee Schedule: .....	37
Step 6: Fabrication and Installation .....	38
Required Materials: .....	38
Inspections & Installation .....	39
Step 7: Post-Construction .....	40
Sponsor’s Responsibilities: .....	40
(IV) Change of ownership: .....	41
Removal .....	41
Reporting for impact studies and other analysis .....	41
(V) Accessibility Elements .....	42
Required Accessibility Features .....	42
Parklet Path: .....	42
Wheelchair Turning Space .....	43
Head Height Clearance: .....	43
Wheelchair Resting Space: .....	43
Tables, Counters and Drink Rails and Benches: .....	44
Sidewalk Condition and Maintenance: .....	44
Parklet Entry: .....	45
Deck Surface: .....	45
(VI) Sacramento Parklet Application Instructions .....	46
Application Checklist: .....	46
(VII) Parklet Final Application Instructions .....	50
Submittal Application Checklist .....	50
1. Final Construction Document Package / Design Documents .....	50
2. Parking Permit Application .....	50

3. Revocable Permit Application Processing Instructions. .... 50  
4. Excavation Encroachment Permit Application Processing Instructions .....51  
5. Letters of Support and Petition of Support: .....51  
6. Proof of Insurance. ....51  
7. Parklet Host Agreement Form.....51  
(VIII) Parklet Budget Worksheet (Sample) ..... 52  
(IX) Parklet Sponsor Agreement Form ..... 53  
(X) Supporters and Outreach: ..... 54

## (I) Program Overview.

*The first attempt at a parklet was created in San Francisco around 2005 as an unofficial activist project by Rebar art and design studio by feeding a parking meter with coins, unrolling grass sod, and placing a potted tree on top. From this movement PARK(ing) day was born. The first official parklet was built in San Francisco in 2010 as an initiative of the San Francisco Planning Department. On September 20, 2013 the Sacramento chapter of the American Institute of Architects sponsored Sacramento United Parking Day. It was pleasantly received by the public and help drive the momentum for a Pilot Parklet Program here in Sacramento.*

*The City of Sacramento Parklet Program will facilitate a partnership between the public and the City of Sacramento to repurpose space designed for on-street parking by safely building out a platform into the public right of way. The parklet provides a path for merchants, community organizations, business owners, and residents to take individual actions in the development and beautification of the City's public realm.*

*A parklet repurposes part of the street into a public space for people. They are intended as aesthetic enhancements to the streetscape, providing an economical solution to the need for increased public open space. Parklets provide amenities like seating, planting, bike parking, and art. While parklets are funded and maintained*

*by neighboring businesses, residents, and community organizations, they are publicly accessible and open to all.*

*Parklets should enhance our downtown core by adding additional welcoming destinations and beauty to the City's right of way. They reflect the diversity and creativity of the people and organizations that sponsor and design them. They also reflect the City's commitment to encouraging walking and biking, creating great streets, and strengthening our communities.*

*Parklets can catalyze vitality and activity in the City's commercial districts. They support local business communities by encouraging pedestrians to linger. Parklets can serve as neighborhood anchors and destination points—providing spaces for neighbors to gather and get to know one another. Collectively, parklets broaden the potential for the public realm to engage and delight while adding much needed open space to our commercial corridors.*

*By sponsoring and creating a parklet you are participating in an international movement that celebrates local grass roots initiative, community building, and sustainable transportation. When completed, your parklet will be enjoyed by countless residents of Sacramento and visitors to your neighborhood and our city.*

*City of Sacramento values and appreciates your willingness to devote your time, creativity, and resources to sponsor and create a parklet. We look forward to collaborating with you on your parklet.*



## (II) Stakeholder Roles



### Application Intake and Design Review:

*City of Sacramento Public Works Department is responsible for ensuring that parklets are well designed, safe and a positive addition to the public right-of-way. Public Works will be your primary point of contact throughout the pre and post design, public outreach, and design processes, and will help steward your project through the permitting process. Public Works can also help you resolve design issues if necessary and is also responsible for ensuring that parklets reflect the goals and intent of the Parklet Program, and that the parklet design articulated in the final construction drawing and approved by the City is what is actually built.*



### Permitting and Inspection:

*City of Sacramento Public Works Development Engineering Department is responsible for ensuring that parklets satisfy all technical requirements of the City Code and Standards. They verify that parklets are well constructed, safe, and accessible. Once your design and plans are approved Development Engineering will issue your permit and conduct inspections during and after parklet construction. Development Engineering is also responsible for ensuring that built parklets meet maintenance and upkeep requirements, remain open to the public, and comply with permit regulations. If significant public concern is expressed about the installation of your parklet administrative fines may be imposed and possible revoking of Encroachment permit.*



### Design, Permit fees, Capital Cost, Liability and Maintenance:

*Project sponsors are responsible for conducting outreach, designing, funding, and constructing their parklets. They also assume liability for the parklet and ensure the parklet is well-maintained and kept in good repair.*

# Sacramento Parklet Program

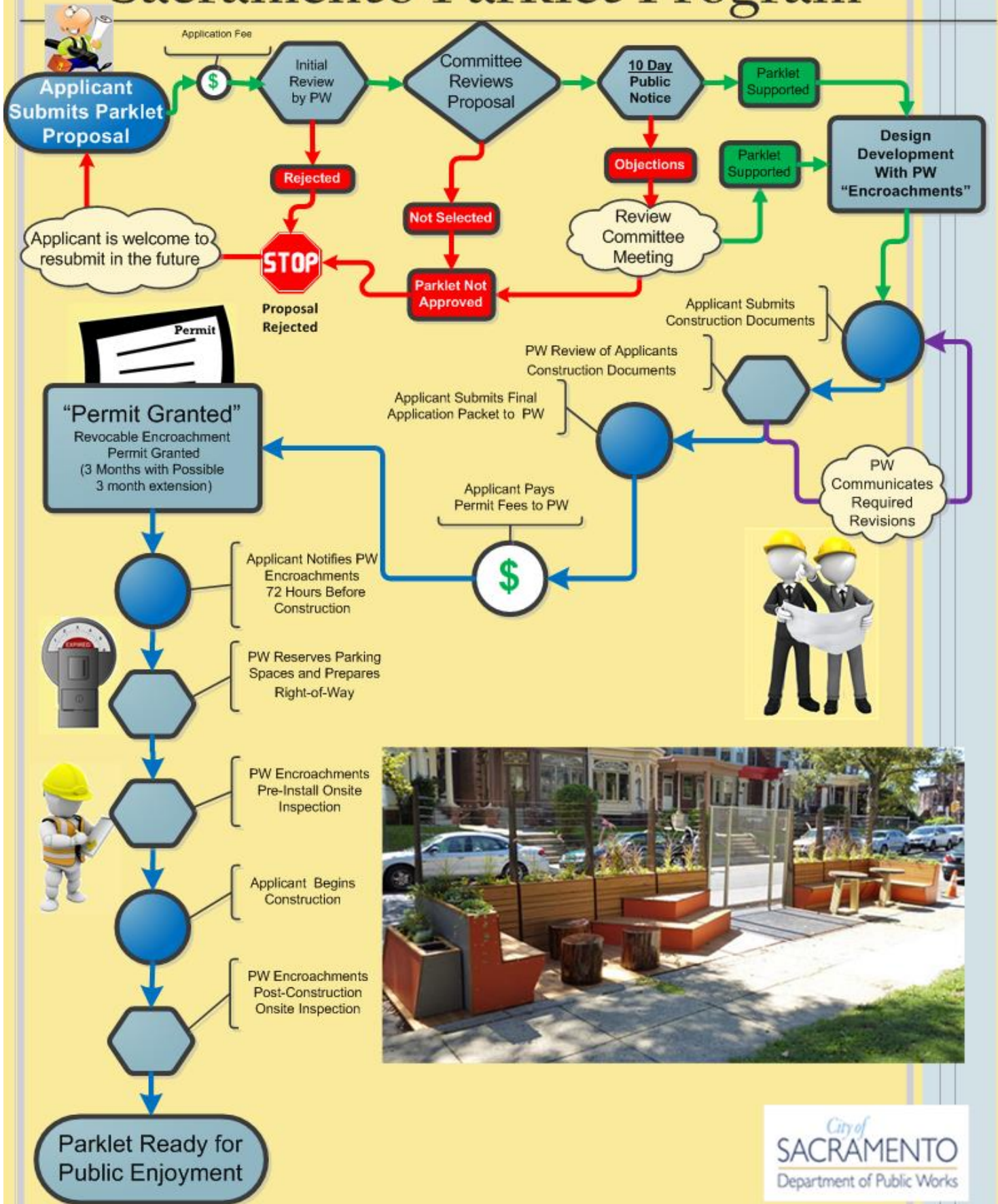

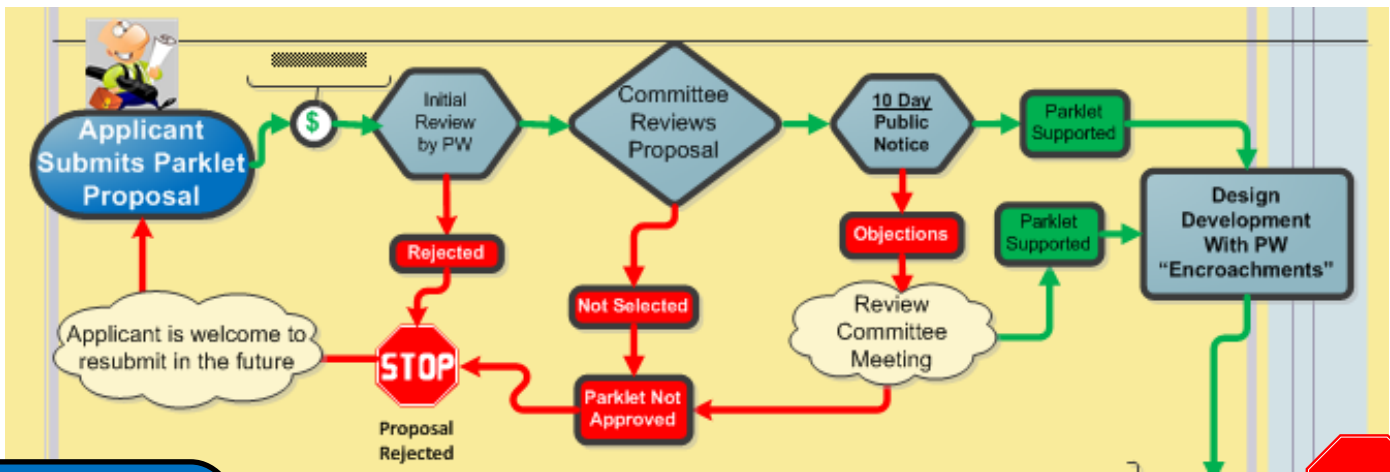

Applicant Submits Parklet Proposal



Proposal Rejected

**Step 1: Applicant Submits Parking Proposal.**

City of Sacramento will accept initial parklet proposals for approximately four weeks after the RFP release date. During this time we will host an open information session for interested applicants.

**Public Outreach:**

You are required to notify property owners as well as adjacent businesses. We request that you receive support from the businesses and or residents along the block face, across the street of the block face, and each of the corner properties that could be impacted by the change in parking of the proposed location of the Parklet by acquiring signatures in support of the proposal. Letters from Business District and Neighborhood Association are also beneficial.

**Step 2: Initial Review by Public Works “Development Engineering”.**

Submit your initial application proposal. The department of Public Works will review your initial application to ensure that it meets the eligibility requirements and that your application is complete. At the time of application submittal a process fee of \$190 should be paid to the City of Sacramento Public Works. The Encroachment staff will review the proposed location and work with Traffic Engineering, Maintenance Services Division, Utilities Department, along with the Community Development Department to see if a parklet located at the proposed location will affect any projects scheduled along the right of way. If something is scheduled along the proposed location then we will reject the proposed parklet with a reason why it was rejected due to an upcoming project along the right of way. We will work with you on resubmitting the application after any project along the right of way is complete. We do not want to accept a proposal and then soon request that it needs to be removed due to planned maintenance on the right of way.

Initial Review by PW

Rejected

Continue to page 11

From Page 11

Continued from page 10

### Step 3: Committee Reviews Proposal.

A team consisting of City of Sacramento’s Community Development Department, Public Works, and Community Leaders will review the proposal and make a recommendation to either move forward with proposal or deny proposal.

**Selection:** The team will select the proposals based on the following criteria:

1. Location. The proposed parklet should be in an active and well-used location, in addition to complying with the location criteria described in the “Parklet Design and Construction Guidelines.”
2. Strong and well-documented community support.
3. Quality of initial design proposal.
4. Creative programming. We encourage creative thinking regarding what will happen on the parklet and who will be involved in its creation and use. For example, consider community partnerships (school, PBID, institution), sustainable features, art, programming for children, partnerships between businesses, etc.

Back to page 10



Parklet Not Approved

Not Selected



### Step 4: 10 Day Public Notice:

If proposal is selected, the City will post a public notice at your location documenting your application for a parklet permit. The public notice will be posted for “10 calendar” days. The purpose of the notice is to alert the public of your application. Any proposed color curb changes will be addressed at this time as well. If no objection is registered, skip to Step 5: Design Development with Public Works Development Engineering. If an objection is registered, see Step 4.1: Potential Review Committee.

#### Step 4.1: Potential Review Committee:

If the City receives objections to your parklet location during the public notice period, the Department of Public Works shall convene a meeting of a review committee with an invitation extended to the public. The review committee will consist of representatives of the departments of Public Works and Community Development and shall consider the proposed Parklet objection(s). The review committee shall consider and hear all testimony in support and in opposition to the proposed Parklet and make a recommendation to the Department of Public Works Project Manager. The Project Manager, in his or her discretion, may recommend approval or conditional approval of the permit subject to further review and final action. If the application is denied, the Project Manager will notify the applicant. The applicant may appeal the denial in writing to the Director of Public Works within 15 days of the Project Manager’s decision.

1. If the Director of Public Works recommends approval or conditional approval, the permit will follow the approval process set forth above in section B.
2. If the Director of Public Works denies the application, the project must wait a minimum of two-years before being eligible for re-submission.

A public committee meeting can add up to additional time to the parklet application process. It is essential that you reach out to the larger neighborhood prior to submitting an application so as to minimize the likelihood that there will be objections to the parklet proposal

Parklet Not Approved

Parklet Support

Objections



Continue to page 12

## Step 5: Design Development With Public Works Development Engineering:

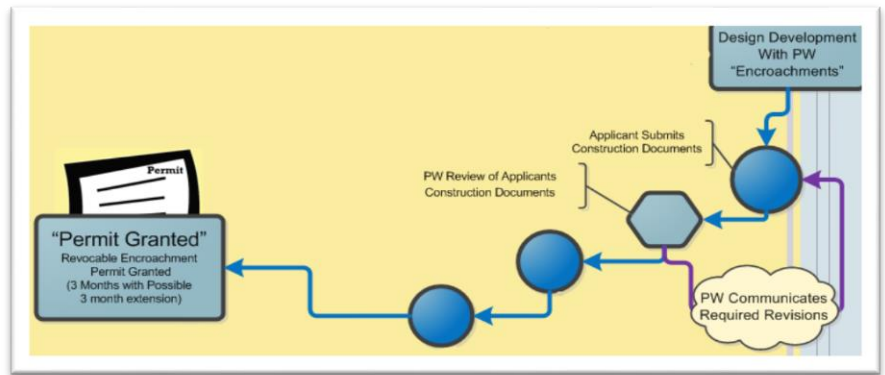

### **Applicant Submits Construction Documents:**



If the committee is in favor of installing a parklet in the proposed location, your parklet application will be assigned to a Public Works Development Engineering Staff member who will work with you and your designer in a collaborative fashion to ensure that the parklet design is appropriate. When developing your final plans, we strongly recommend that you work with a designer to propose a project reflecting the “Design and Construction Guidelines” and “Accessibility Elements for Parklets”.

You will have three months once you have been notified that your proposal has been accepted to submit your final construction documents package to City of Sacramento Public Works Development Engineering staff.

Parklet applicants may request a three-month extension for submitting the final construction document package. However, applicants that request the three-month extension will need to comply with any new design controls or program requirements. This may require revisions to your final construction document package.

### **Interdepartmental Final Review and Approval:**

Public Works Department will forward your final plans to the Community Development Department, for the Building and Planning division, and possibly the Fire Department for their review. You may receive additional comments from these agencies that require additional revisions or clarifications to your final document set. Your Public Works contact will coordinate with you and help you with the comments received if any help with you submitting a final plan for the parklet. Adherence to the “Parklet Design and Construction Guidelines” and “Accessibility Elements for Parklets” minimizes the likelihood of your design requiring revisions. Letters of support from property owners and adjacent businesses is also required by Public Works at this stage.

### **Permit Issuance:**

After your design has been approved by Public Works we will issue an invoice for payment of fees. Once the City of Sacramento receives payment it will issue your Revocable Encroachment Permit. A good faith estimate of the potential fees is about \$2000 see “Interdepartmental Review and Approval” section of this document for more details on fees. The fees may vary depending on how much time is spent processing your application, how many parking spaces your parklet will occupy, and whether your parklet is sited on a street with metered parking. You may not undertake any on-site installation until you receive the approval and Permits.

## **Step 6: Fabrication and Installation**

### **Construction:**

*You have up to three months after the date Public Works issues your permit to begin constructing your parklet. You may request an additional three-month extension. However you will need to comply with any new design controls or program requirements. This may necessitate required revisions to your final construction document package.*

### **Pre-Installation On-site Inspection:**

*You or your contractor are required to notify Public*

*Works Encroachment staff at least 10 days before beginning any site work to schedule a pre-installation on-site inspection. You will be directed to the Parking Division at this time to have the parking spaces reserved up to 72 hours prior to construction of the Parklet. That way the spaces are cleared of vehicles and ready for construction.*

### **Installation:**

*On-site installation may not exceed thirty (30) days. Failure to finish constructing your parklet within the 30-day window may result in punitive action by the City, such as a fines or the revocation of your permit or required removal of the parklet*

### **Post –Construction On-site Inspection:**

*You or your contractor are required to notify Public Works Encroachment staff within 48 hours of the completion of parklet construction to schedule a post-construction on-site inspection.*

### **Post-Construction:**

*Public Works will continue to monitor your parklet for compliance with public access requirements and the maintenance agreement. Failure to comply may result in revocation of your parklet permit. Once granted, parklet permits are reviewed annually for renewal. The City may request your participation in assessments and studies of the Parklet Program.*

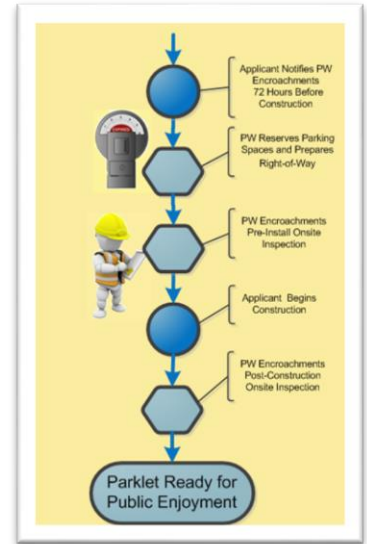

# Finished



## **Step 7: Post Construction**

*City of Sacramento Public Works Staff will continue to monitor your parklet for compliance with public access requirements and the maintenance agreement. Failure to comply may result in revocation of your parklet permit. Once granted, parklet permits are reviewed annually for renewal. The City may request your participation in assessments and studies of Sacramento's Parklet Program.*

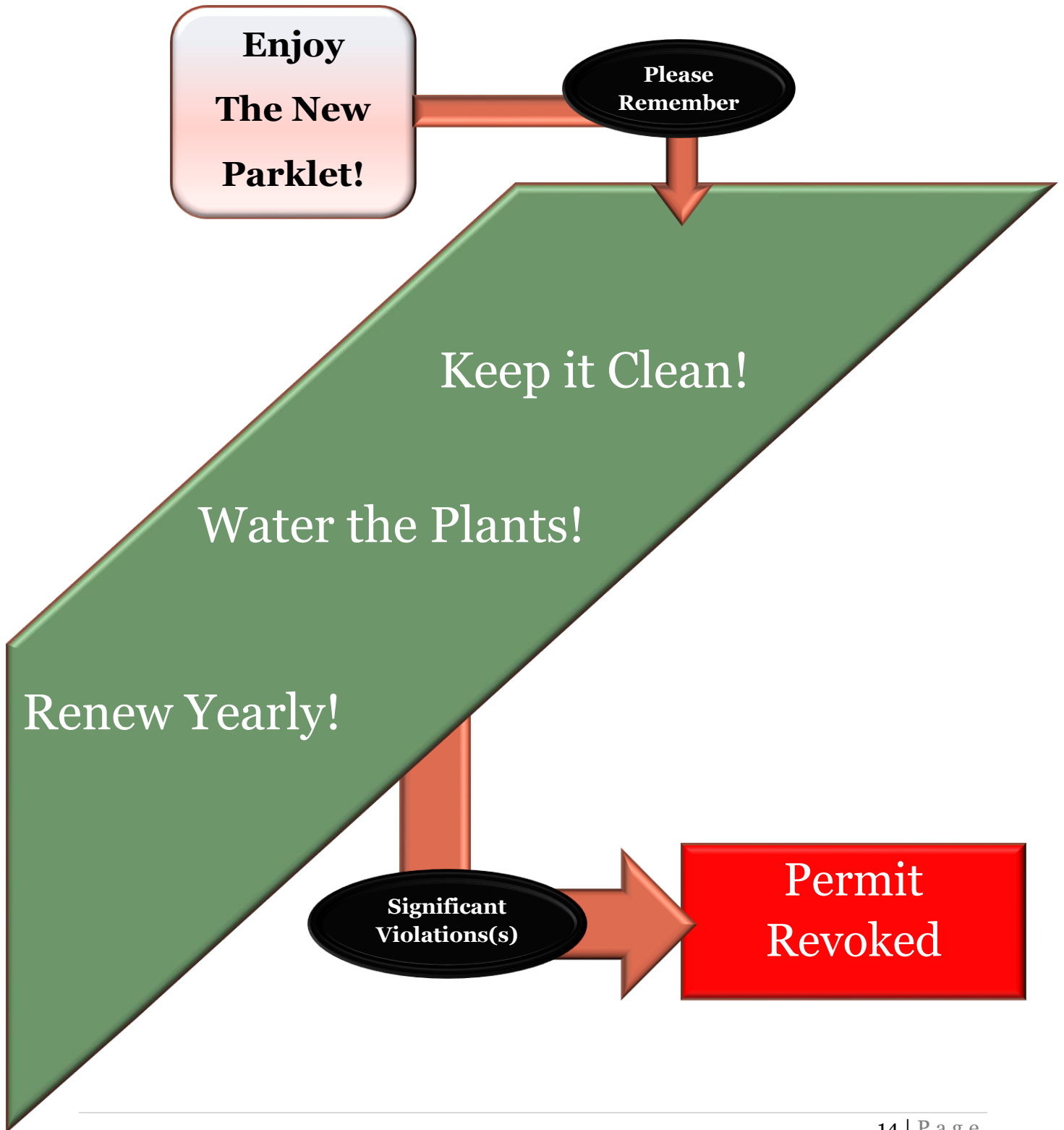

## **Important Consideration:**

### **Parklets are Public:**

*City of Sacramento's Parklet Program is intended to create publicly accessible open space that adds vitality to the public realm. For example, members of the public are welcome to use and enjoy a parklet regardless of whether or not they patronize the sponsoring business. Accordingly, many of the guidelines listed below are intended to ensure parklets are designed to feel welcoming and inviting to all users.*

### **Designing for the urban landscape:**

*Despite their small scale, parklets can pose deceptively challenging design problems. Parklet designers must resolve potentially complex site issues like maintaining access for persons with disabilities on sloped streets or maintaining positive drainage underneath the parklet structure. Parklets must also be designed to be easily removed without damaging the curb, sidewalk, or underlying street or roadway, yet be durable enough to withstand the pressures of being outside in the urban landscape for years at a time. Our experience has shown that working with a professional designer such as an architect, landscape architect, or industrial designer can expedite the permit process by providing complete plans, reduced maintenance costs, and often a higher quality design.*

### **Design is iterative:**

*Design is by nature an iterative process — in this case between the applicant, the designer, and the City. At times this process can feel subjective. The City's intent is not to impose a particular design aesthetic onto your parklet, but to promote unique parklets with a look and feel to reflect the individual character, location and creativity of the parklet sponsor and designer. The guidelines are also intended to ensure that parklets are safe for the people who inhabit them and are accessible to all.*

### **Your patience is appreciated:**

*City of Sacramento will need to review your location in the predesign process and will subsequently review your design during the final review process. Your patience throughout this process is very much appreciated. Following City of Sacramento Design and construction guidelines and the accessibility elements for parklets can reduce the time it takes for you to receive your permit by reducing the risk that you will be asked to make design revisions because your parklet design does not meet the goals and intent of the Parklet Program or the final submittal package is missing elements needed by the City to review your design.*



# (III) Steps to Parklet

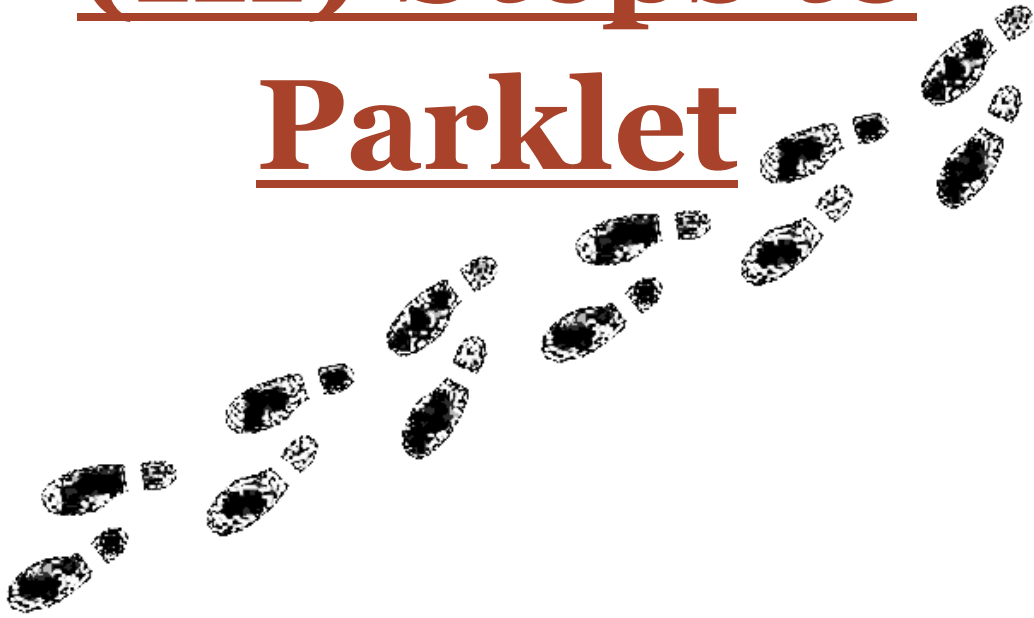

## Step 1: Parklet Location Criteria

**Speed limit:** Parklets are permitted on streets with speed limits of 25 mph or less. Parklets on streets with speed limits over 25 mph may be considered on a case-by-case basis.

**Corner locations:** In general, parklets must be located at least one parking space away from an intersection or street corner. Parklets close to corners can be more exposed to the risk of a collision by motorized vehicle. In some instances, a bike corral at least 15 feet in length, a curb-extension (bulb-out), or some other physical barrier that would protect the parklet in a corner location may allow the City to consider a corner parklet on a case-by-case basis.

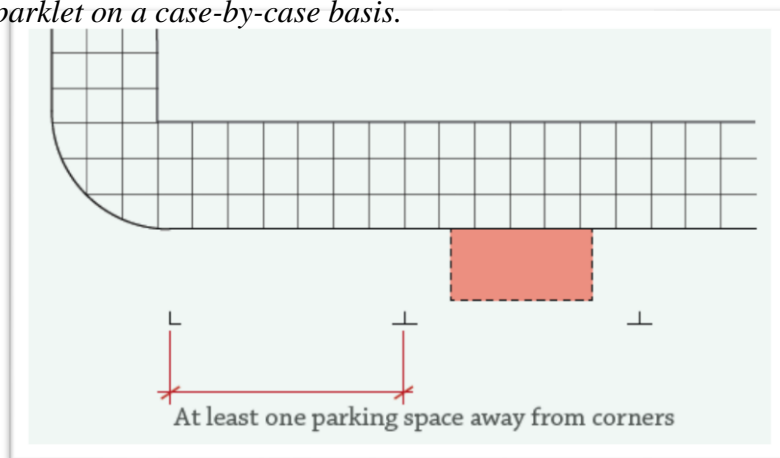

**Parking spaces:** Parklets can be sited along the curb line on streets where on-street parking spaces exist. They can be considered in any location where there are or would be space(s) for on-street parallel, angled, or perpendicular parking, including spaces with metered or unmetered parking. City of Sacramento Parking Division has determined that the installation of parklets within existing on-street parking spaces are an appropriate use of these spaces.

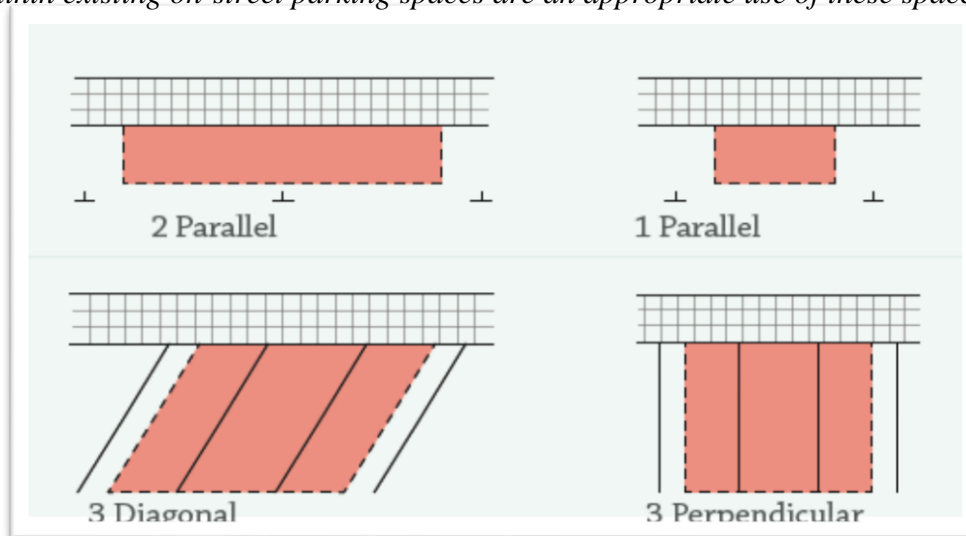

**Driveways:** Parklets may be installed in front of a driveway if the applicant is the owner of the driveway or obtains written permission from the property owner to install the parklet. If the driveway has been abandoned or no longer provides access to off-street parking space, the driveway may be incorporated into the parklet design.

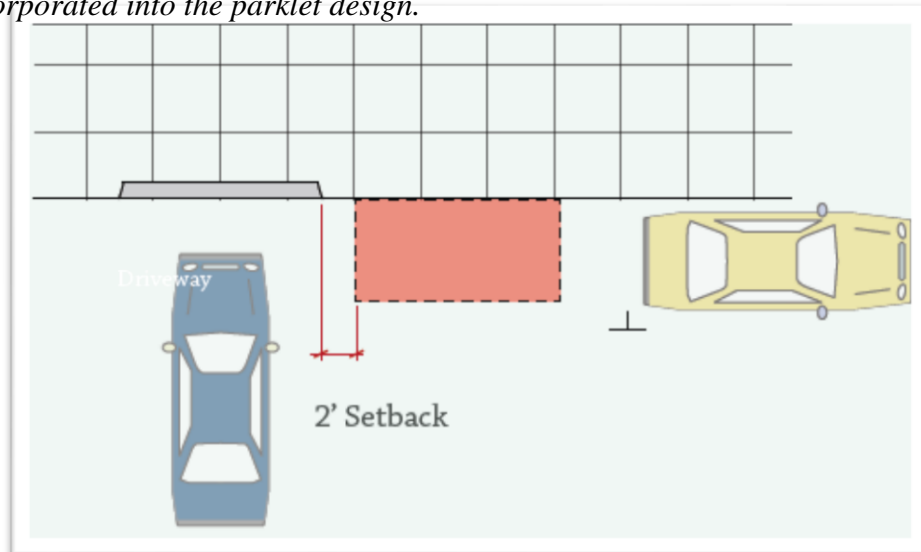

**Other locations:** Other locations adjacent to the curb will be considered on a case-by-case basis.

**Street slope:** Parklets are generally permitted on streets with a running slope (grade) of five percent or less. When installed on streets with running slopes of three percent or greater, parklets will need to include a wheelchair rest area.

Parklets may be permitted on streets over five percent if they can provide safe access and turnaround area for wheelchair users. See the “Accessibility Elements for Parklets”. Parklets on streets with a running slope over five percent pose significant design challenges. For those parklet proposals, you should anticipate a longer and more robust review process, and be aware there is a somewhat greater chance that such parklets will not be issued permits.

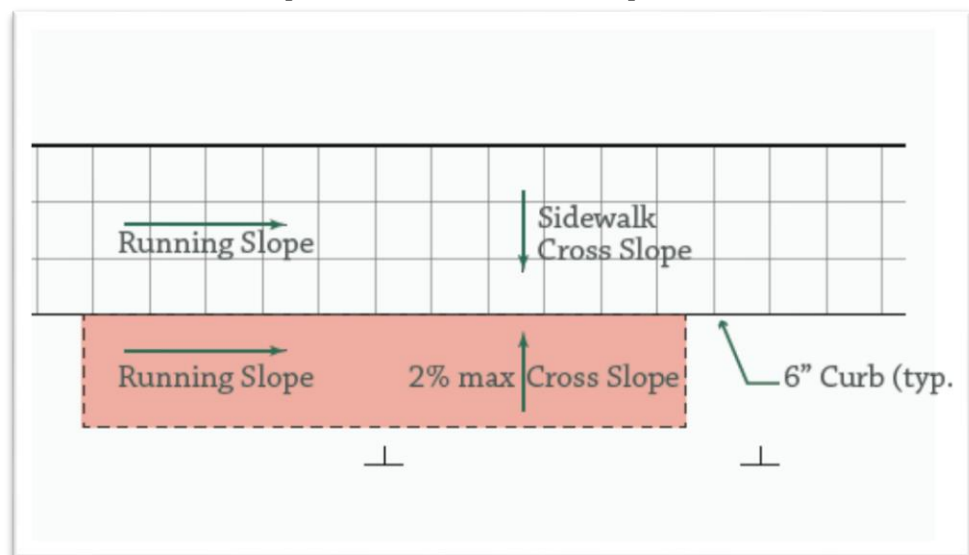

**Curb color zones:** Applicants must take special care when installing or constructing a parklet near or in a color curb zone. Parklets may replace yellow, white, or green zones or motorcycle parking if there is 1) support for their removal and 2) appropriate alternative locations to restore them.

Parklets are not allowed to permanently replace blue zones designated for disabled parking. If a blue zone exists in the location for a proposed parklet the requester may work with the City's ADA coordinator on a relocating the blue zone in close proximity to the original disable space. In most instances parklets are not permitted in red zones. Parklets may be allowed in red zones at small remnant spaces along the curb lane, such as adjacent to a driveway. City staff will consider these requests on a case-by-case basis.

Please be aware that applicants are responsible for any costs associated with removing and relocating a color curb zone. This will add extra time to the permit process. Parklet applicants seeking to reconfigure colored curb zones or motorcycle parking will need to coordinate with the City of Sacramento Traffic Engineering Department before they can be issued a permit.

For more information on removing or relocating curb color zones, please contact us at (916)-808-5307 or email us at [www.trafficengineering@cityofsacramento.org](mailto:www.trafficengineering@cityofsacramento.org).

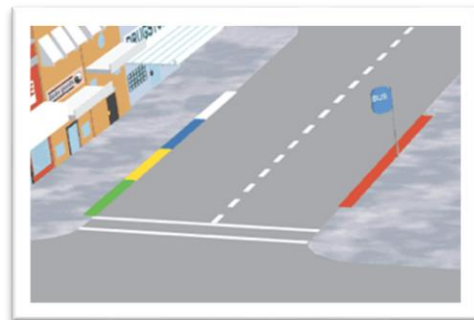

**Utilities:** Parklets are not permitted in front of a fire hydrant or above a fire hydrant shut-off valve. Parklets may not be constructed over utility and manhole covers. Be sure to make a thorough inventory of utility access covers in your proposed parklet area by checking under parked cars.

You must provide access to any City or public utility company that may have underground conduits beneath the constructed parklet. Access may require that you temporarily remove all or a portion of the constructed parklet.



**Long-term City projects / future City-sponsored streetscape improvements:**

*As part of its initial screening process, the City reviews proposed parklet locations for potential conflicts with future programmed streetscape improvements, repaving projects, and future expansion of public transit. The City may reject parklet proposals that conflict with impending streetscape improvements. Parklets installed on streets scheduled for future improvements will likely need to be removed prior to the improvements being constructed.*



**Transit:** *Parklets are not permitted in bus zones but could possibly be located adjacent to a bus zone.*



**Proximity to other parklets:** *As the number of parklets in the City increases, oversaturation may become an issue in some neighborhoods. The City will prioritize parklets proposal from under-represented neighborhoods.*

## Step 2: Creating an Initial Site Plan

**An initial site plan:** *Showing the existing street and sidewalk environment is required with all applications. The site plan does not need to show the proposed parklet design, but should show the footprint of the proposed parklet, all street and sidewalk utility covers, any poles, signs and meters, any sidewalk furniture, and color curb zones 24 feet on either side of the proposed parklet location. Site plans must be drawn to scale (by hand or computer). The initial site plan may be hand drawn, as long as it is legible and includes all the elements previously listed. When creating your initial site plan, consider: Your building, adjacent properties (include addresses) and their building entrances.*

- Existing sidewalk width(s).
- Existing curb cuts and driveways.
- Adjacent bike lane or auto traffic lane.
- Existing parking spaces with dimensions.
- Existing parking meters, with numbers of all meters to be removed (these numbers are generally posted on the meter facing the street, and are formatted as follows: PKGSXXXXX).
- Other existing sidewalk features near the proposed parklet area (fire hydrants, streetlights, utility access panels, bike racks, etc.).
- Existing utilities in the street and on the sidewalk and covered by or adjacent to the proposed parklet.
- All colored curb zones (red, yellow, green, white, blue).
- Existing street trees and tree pits.
- Proposed parklet footprint and dimensions.
- Parklet setback dimensions (48 inches from adjacent parking spaces and 12 inches from adjacent bike lane or auto traffic lane).

**Parklet footprint: parallel parking.** *When replacing parallel on-street parking, most parklets are the size and length of one or two parking spaces. The City will consider larger parklets depending on circumstance and existing site conditions..*

- All parklets are required to include setbacks on either side to buffer the parklet from adjacent on-street parking spaces and driveways. Parallel parking spaces in City of Sacramento typically range between 20 to 24 feet in length. With standard 4-foot setbacks on both ends and a 24-foot parking space, typical parklet dimensions would be:*

<i>Equivalent Parking Spaces (24')</i>	<i>Setbacks (2x 4' = 8')</i>	<i>Parklet Structure</i>
<b>1 Parking Space</b>	<b>8 feet</b>	<b>16 feet</b>
<b>2 Parking Spaces</b>	<b>8 feet</b>	<b>40 feet</b>
<b>3 Parking Spaces</b>	<b>8 feet</b>	<b>64 feet</b>

**Parklet footprint: diagonal parking:** For diagonal and perpendicular spaces, the edge of the parklet must be set back 36 inches from the adjacent parking space on either side. This setback space must be included within the parklet space, and not be taken from the adjacent space.

Where parklets are installed in areas with diagonal or perpendicular parking, they are typically designed to be the size of three or more combined parking spaces. Due to required setbacks, a one- or two-space parklet would likely pose significant accessibility issues and pose significant design challenges.

### Adjacent parking: parallel and diagonal parking:

Parklets may not use part of any adjacent parking spaces. In areas where parking is not striped, the parklet shall not leave an “orphaned” space that is too small to use as a full parking space.

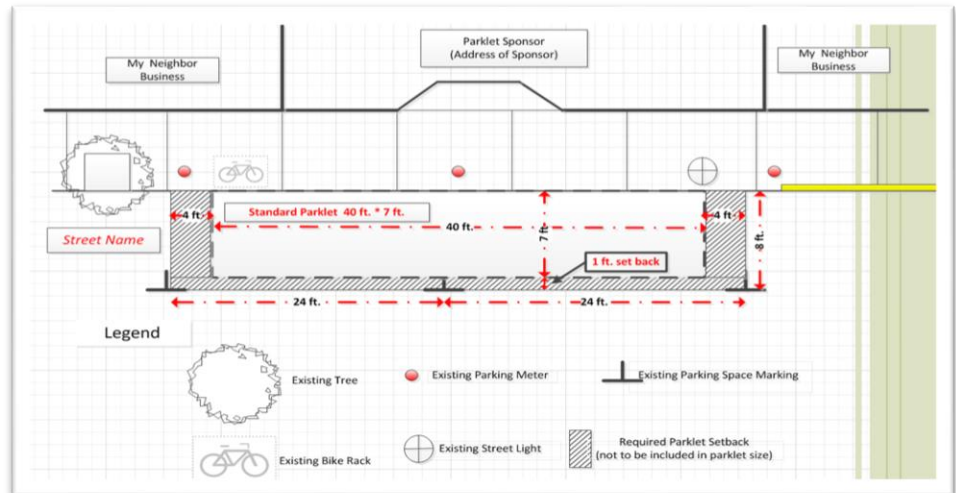

### Reflective

**elements at corners:** Reflective elements are required at the outside corners of all parklets. Soft-hit posts are a standard solution deployed at the outside edges; however the City will consider additional reflective elements incorporated in the parklet design. See Step 6: Fabrication and Installation: Required Materials.

**Wheel stops:** For parklets in parallel parking spaces, a three-foot wheel stop must be installed one foot from the curb at the edge of the front and back parking spaces. When parklets are installed adjacent to parallel parking spaces, wheel stops should be setback four feet from the parklet structure. For angled parking spaces and adjacent to driveways, City staff will work with you to determine the appropriate location for wheel stops. Wheel stops should be made of recycled rubber; concrete wheel stops are discouraged. See Step 6: Fabrication and Installation : Required Materials.

**Site conditions:** Your initial site plan should accurately reflect the existing site conditions and include streetscape features like adjacent bike racks, utility covers, street poles, existing signs, street trees, tree wells, etc.

**Driveways:** Parklets located next to driveways must be setback two feet from the outside edge of the driveway. If the parklet is located in front of a driveway, the platform must extend over the driveway so that the entire platform surface is level with the sidewalk.

**Parking meter location numbers:** If your parklet is located in an area with metered parking, you will need to show the locations of the parking meters to be removed and include their associated parking meter number(s). The number can be found on the parking meter and has the following format: PKGSXXXX



## PHOTOGRAPHS OF EXISTING CONDITIONS

Your submittal package should include photos taken from specific angles, views, and locations identifying existing sidewalk and streetscape conditions adjacent to your proposed parklet site. Please name images to conform to the naming conventions established in the Submittal Photos Standards (below). Photograph all utilities, sidewalk, and pavement anomalies. Include photos from both a pedestrian perspective and a vehicle perspective.

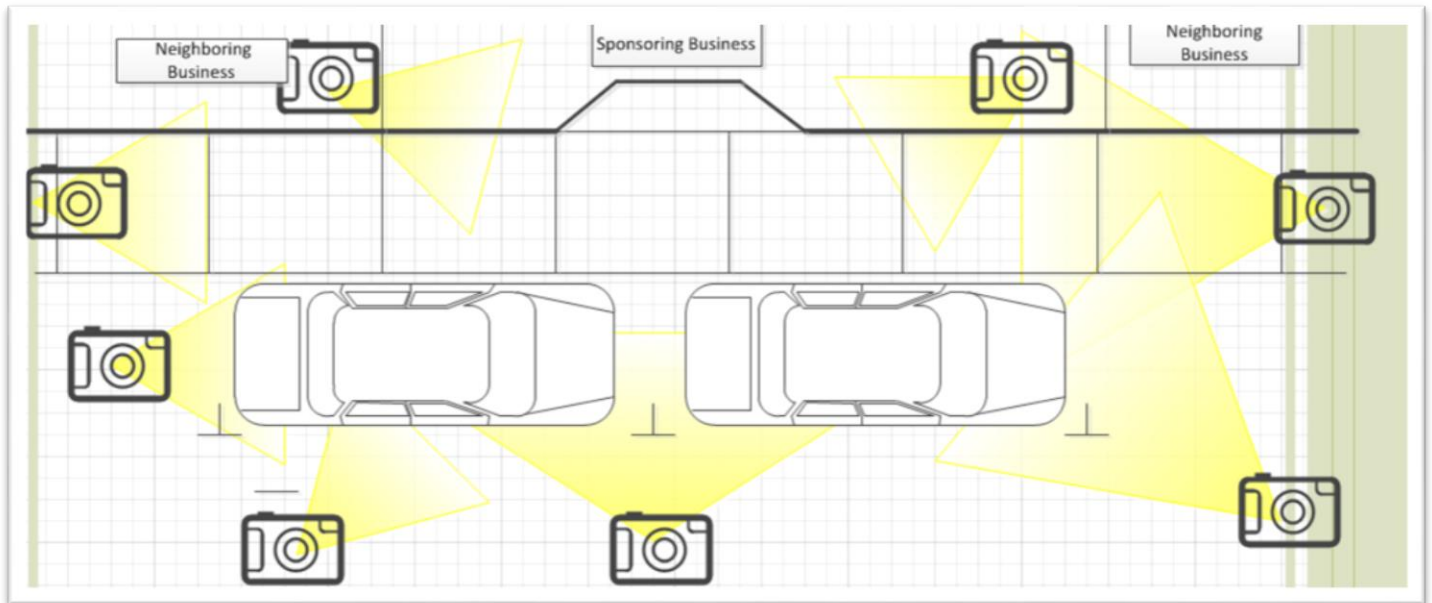

## WRITING A PROJECT NARRATIVE

The project narrative is a short project description explaining your vision for your parklet. Applicants are encouraged to emphasize:

- Response to the Parklet Program goals.
- Why you want to build the parklet.
- How the proposed location will benefit from the parklet.
- Ideas about how the community can participate in the creation and/or stewardship of the parklet.
- Ideas for programming the parklet.
- If known, include information about who will design the parklet.



## ILLUSTRATIVE DESIGN CONCEPTS (OPTIONAL)



In addition to your project narrative; you may also submit design drawings, sketches, or other documents. These optional supplemental materials may help clarify your parklet vision to the City.



## **Step 3: Building Neighborhood Support**

**Demonstrated Support for Your Parklet Project:** *It is an essential part of the process and should be included with your initial parklet application. Parklet application submissions that do not include documentation of community outreach will not be considered. Outreach efforts will help show support among nearby businesses, residents, or other stakeholders and more likely gain positive support in the surrounding areas. You should also reach out to your Council Member and inform him or her of the proposal; and ideally, get support for the proposed parklet.*

*Full consensus in support of your project from every business on your block is not a requirement for your parklet proposal to move forward, but it's important to demonstrate that you have done adequate outreach in case someone files an objection to your parklet application.*

**Property Owners:** *Applicants are required to notify the property owner(s) from whom they lease their space and whose property fronts the proposed parklet. If you own your property, indicate that in your outreach package.*

*Applicants are encouraged to draft a letter to neighboring stakeholders to obtain support. Letters should highlight the benefits of the proposed parklet for the local community, the number of parking spaces the parklet will occupy, and any potential changes to colored curb zones. It should also include contact information for the person signing the letter. See Supplements: Sample Letter of Support.*

### **Adjacent businesses:**

*At a minimum, you should notify any businesses which front and are adjacent to your proposed parklet location.*

**Property Business Improvement District:** *If your area has one, you should notify the executive director of the business district.*

**Other neighborhood organizations:** *If your proposed parklet location does not have an active Property Business Improvement District or your proposed parklet will not be located along a commercial corridor, you should notify your local neighborhood association.*

**Petitions for nearby residents and customers:** *Some parklet applicants have posted a petition in their business where customers and nearby residents can voice support for the parklet. If you chose to do this, the petition should include check boxes where signers can indicate if they live on the block where the parklet will be installed or in the nearby neighborhood. Petitions should also include an opportunity for customers to leave their contact information and including their address. See Supplements: Sample Petition of Support.*

### **Required Outreach**

*Full consensus in support of your parklet is not required. However, signed letters of support are the most effective tool for demonstrating effective outreach and support for your parklet. If you are unable to obtain a letter of support from your stakeholders listed above, please submit a copy of the correspondence which demonstrates that you notified them of your intent to install a parklet.*

## **Step 4: Initial Proposal Review**

### **Shortlist Selection**

*After the completion of the proposal process, City staff will conduct an internal review of all parklet applications received. Proposals will be evaluated based on the following criteria:*

**Proposed parklet location meets the minimum location criteria** *See Step 1: Selecting the Parklet Location.*

**Proposed parklet location does not conflict with future city streetscape repaving projects or other planned streetscape improvements.** *See Step 1: Selecting the Parklet Location.*

**Strength of the parklet proposal:** *City staff strives to accommodate as many parklet proposals as possible. Proposals that meet the minimum location criteria and are not in conflict with future streetscape improvement projects will be scored based on the following criteria:*

- Fit with the Program Goals.*
- Quality and robustness of outreach.*
- Parklet saturation in the neighborhood.*
- Site conditions.*

*Program goals and public outreach are weighed heavily in the initial selection process. Establishing a strong vision with your project narrative and conducting thorough outreach with community stakeholders will increase the likelihood of your proposal moving forward most expeditiously.*

### **Selecting the Proposal**

*An interagency team consisting of City of Sacramento Public Works, Planning, and other key organizations based on proposed location of the parklet such as a PBID or local association that plays a role in the proposed location.*

### **Public Notice**

*If your parklet proposal is selected, you will be issued a public notice. The public notice is an 11 x 17 inches sheet of paper to be prominently displayed in the front window or on the façade directly facing the proposed location of the parklet. The notice period lasts for 10 calendar days and will be posted on-site by the Public Works Department.*



## Potential Review Committee Meeting

*If someone files an objection to your parklet during the notification process, Public Works will convene a meeting of a review committee with an invitation extended to the public. The Parklet Program Manager will make a final decision as to whether or not the proposed parklet should move forward. The Review Committee Meeting process may add a few months to the permitting process. If your parklet goes to a Review Committee Meeting, Public Works will charge an additional fee to cover the staff time associated with the additional process.*

*The Review Committee Meeting gives local residents and business owners an opportunity to voice their opinions in favor or against the project. The manager of the Parklet program will factor levels of community support and opposition to the project in his or her recommendation as to whether or not the parklet should move forward. Conducting a robust outreach effort increases the likelihood that you will be joined by supportive stakeholders who can speak in favor of your project if it goes to a Review Committee Meeting.*

*Both parties will have an opportunity to appeal the Project Manager of the Parklet Program decision in writing when the Project Manager issues a determination. See Interdepartmental Review and Approval.*

*In other Cities that have Parklet programs it has shown that people are more likely to support a project when they are approached directly by the project sponsor as opposed to seeing a public notice posted in your window or received by mail. Talking to your neighbors also gives you a chance to listen to their concerns and to incorporate them into the design proposal, which can reduce the likelihood that they will file an objection to your project.*

## **Step 5: Design Development**

### **Designing phase:**

*After the City has reviewed your parklet proposal, and your proposed location clears the voting process, it's time to begin refining the design of your parklet. We recommend that you work with a designer to help refine your vision for the parklet and work out the construction and aesthetic details. Designers help their clients navigate the City's permitting process as well as design and construction challenges. During this phase of the project, much of the communication will likely happen between City of Sacramento Encroachment staff and your designer.*

### **Partnership:**

*Designing a parklet is an iterative and collaborative process. City staff will work with you to ensure that your parklet is designed to a high standard that meets the intent of the Design and Construction Guidelines and is safely constructed and accessible to all.*

**Disclaimer:** *These are guidelines and may not be required in all cases. Similarly there may be instances where City staff requires additional design interventions not covered in these guidelines. Your parklet approval is ultimately subject to the discretion of the City of Sacramento Public Works Department.*

## **General Guidelines**

**Parklets are public.** *Parklets are public spaces and should feel open and welcoming to passersby, even those who may not intend to patronize your business.*

**No advertising.** *Logos, advertising, or other branding is prohibited. A small unobtrusive plaque recognizing project sponsors and material donors may be acceptable.*

**Include public parklet sign.** *You are required to install two standard City of Sacramento "Public Parklet" signs which state that all seating must be publicly accessible at all times. Make sure to incorporate placement locations for these signs. See Section 4.A: Required Materials for more detail on signage.*

**Design for easy removal.** *Because parklets may sit on top of critical infrastructure and utilities such as gas lines, sewer and water mains, they need to be designed for easy removal in case of an emergency. No parklet component may weigh more than 200 pounds per square foot.*

**Be creative.** *Think outside the standard tables and chairs on a platform!*

## **Inclusive Design (ADA Compliance)**

*All parklets must comply with the Accessibility Elements for Parklets (see Supplements). Your parklet design must be accessible and welcoming to all users, including people with physical disabilities, wheelchair users and those with impaired vision. Inclusive design considerations will affect many aspects of your parklet design ranging from how you allocate space within the parklet to the materials you chose to use. A few examples of the issues City staff will evaluate while reviewing your parklets design include:*

- Slip resistant surface materials.*
- Ensuring wheelchair users can access and enjoy your parklet.*
- Ensuring your parklet, and some seating within your parklet, is accessible to people with disabilities.*

# The Platform

**Base:** *The platform provides the structural base for the parklet. The City strongly recommends consulting a design or construction professional to ensure that the platform will be sturdy and safe.*

**Bolting:** *Bolting into the street or penetrating the surface of the road in any way is strongly discouraged and may not be allowed without a restoration plan and an excavation bond posted by the applicant and their contractor. Parklets may be bolted to the existing curb, with specific restoration requirements.*

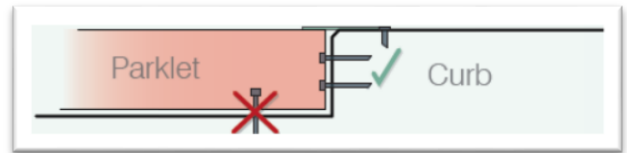

**Platform surface:** *The top of the parklet platform must be flush with the sidewalk with a maximum gap of one-half inch. In the case of a sloping street, staff will work with the designer to address issues of access. (See Supplements: Accessibility Elements for Parklets).*

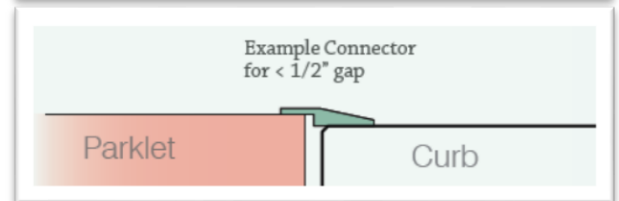
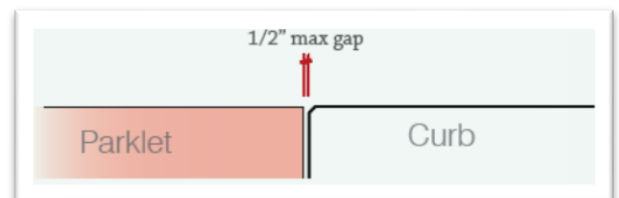

**Access:** *If the platform base is not solid, the space underneath the platform surface must be accessible for maintenance through access panels, removable pavers, etc.*

**Concrete:** *If using a concrete base for the parklet floor, the concrete cannot be poured directly on the road surface. A plastic slip-sheet can be used to prevent the concrete from binding to the roadbed below. To facilitate easy removal of the parklet, the concrete floor should not include structural rebar and must weigh less than 200 pounds per square foot.*

**Surface materials:** *Loose particles, such as sand or loose stone, are not permitted on the parklet.*



**Drainage:** The parklet cannot impede the flow of curbside drainage. Designers are strongly encouraged to cover openings at either end of the parklet with screens to prevent blockage from debris.

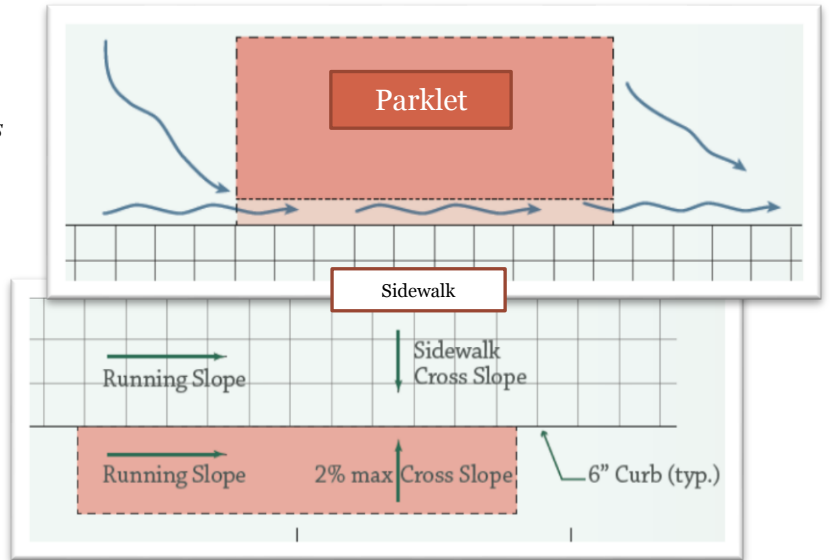

**Platform cross slope:**

Parklet platform rest areas cannot exceed two percent cross slopes. Your final construction drawings will need to show spot elevations for both the sidewalk and the platform areas. For an example, see Supplements: Sample Final Construction Documents.

For more information, see Supplements: Accessibility Elements for Parklets.

**Street crown and curb height:** Most Sacramento streets are crowned (parabolic in cross-section) and typically edged with a six-inch-high curb. This is to ensure that storm water flows towards the curb and gutter during a rainstorm. The curb is intended to prevent water from jumping the curb and flooding adjacent buildings. This means that the elevation of the street rises the further you move from the curb, effectively reducing the amount of space to build the parklet platform. Whereas along the curb there may be 6 inches of clearance for your platform structure, clearance can be reduced to as little as 2 inches further into the street. Furthermore, both curb heights and street crown heights vary with each street segment.

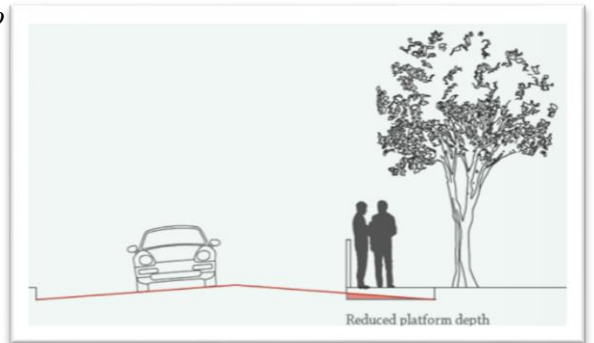

Applicants and designers are strongly advised to take field measurements before beginning the design to make sure their proposed platform solution will fit within the allotted space and satisfy all slope and accessibility requirements.

**Extend the sidewalk:** Parklets should be designed as an extension of the sidewalk, with multiple points of entry along the curbside edge. This may not be feasible on steeply sloped sites.

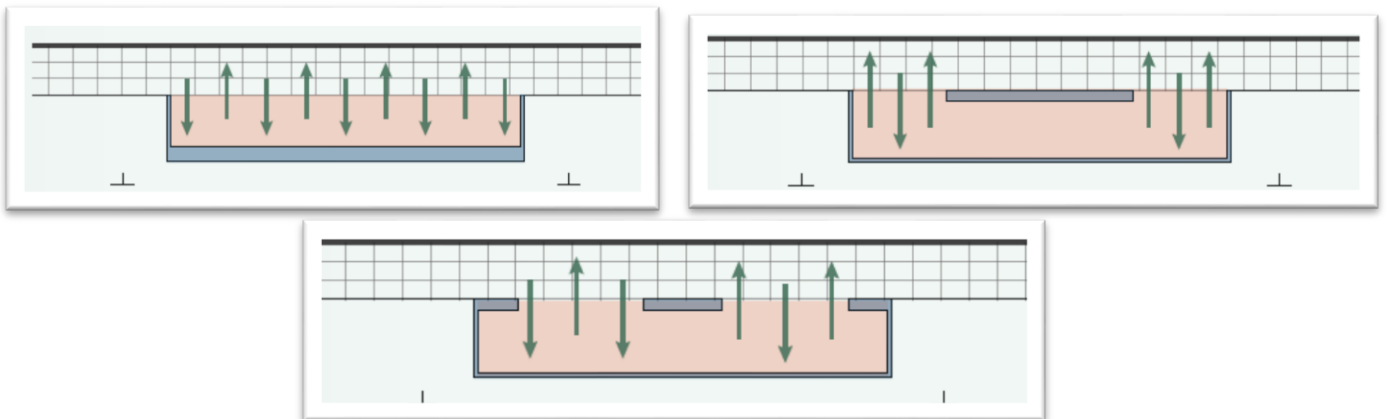

# The Enclosure

**Buffer the edges:** Depending on the location, the parklet should have an edge to buffer the street. This can take the form of planters, railing, cabling, or some other appropriate buffer. The height and scale of the buffer required will vary depending on local context. For example, on some low-traffic streets, a continuous edge may not be required. (If cable railing is used, spacing between cables cannot exceed six inches). See *Supplements: Accessibility Elements for Parklets*.

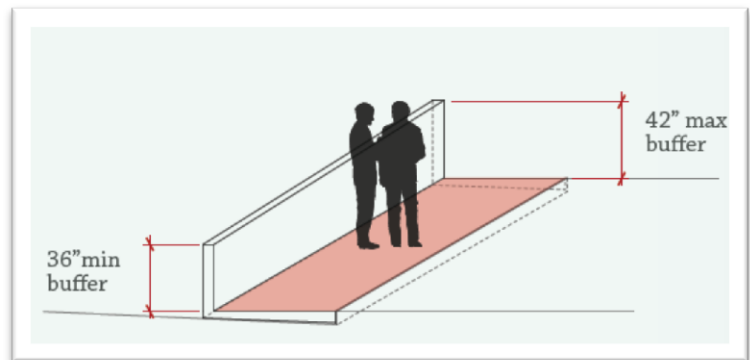

**Maintain a visual connection to the street:** Your parklet design should maintain a visual connection to the street. Continuous opaque walls above forty-two inches that block views into the parklet from the surrounding streetscape are prohibited. You are allowed to include columns and other vertical elements.

**Avoid overhead elements that span the sidewalk:** Overhead elements that span the sidewalk and connect the parklet to the adjacent building façade are discouraged. Such proposals may be considered on a case-by-case basis, and will require a minimum vertical clearance of eighty four inches above grade.

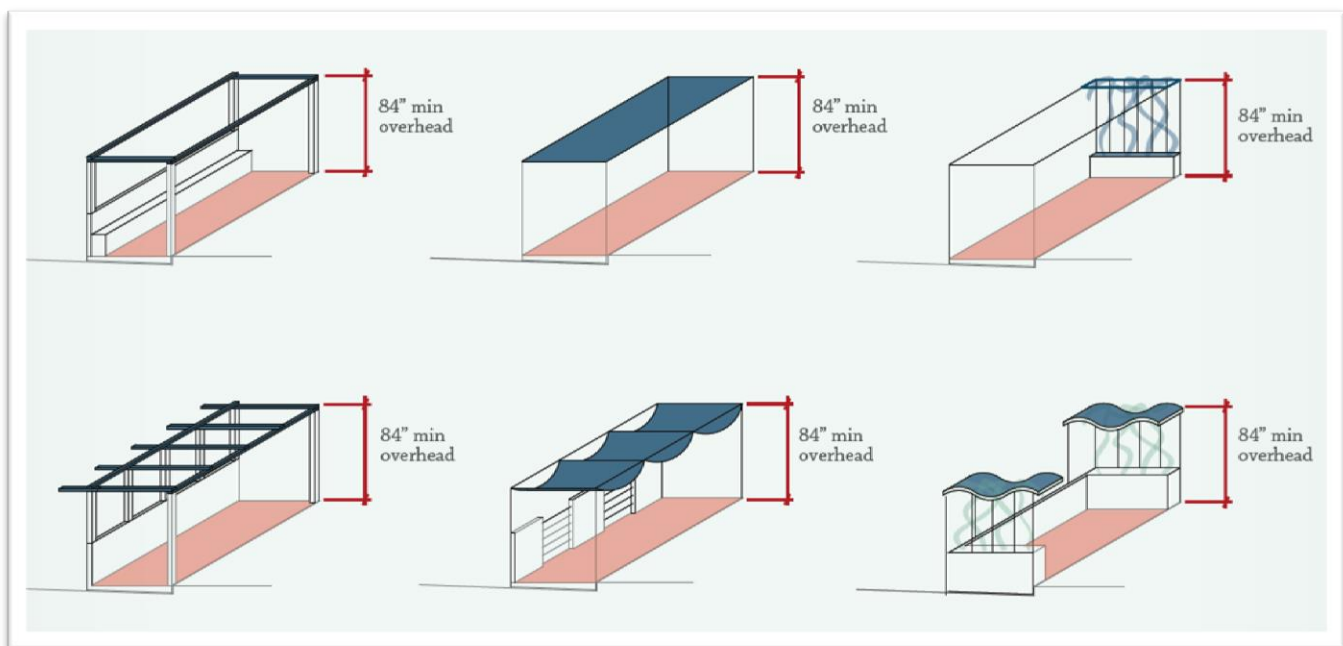

**Consider the back of the parklet.** While not visible from the sidewalk, the parklet's back is highly visible from across the street. Large blank walls can be an invitation for tagging. This can be mitigated by adding visual interest like pattern, color, modulation or planting.

**Parklet's Positive Edge at Perimeter of Deck Surface:** *Parklets need a Positive Edge along the open sides of the Deck Surface that is parallel to the vehicular traffic lane, to inhibit people who, while lingering, may inadvertently wander into vehicular traffic. Positive Edges serve to reduce potential tripping hazards at drop-offs along open sides of the Deck Surface.*

- *A Positive Edge along vehicular traffic lanes may be achieved by providing a railing of no less than 42 inches in height with openings of no more than 4 inches, or by other means as described in the next paragraph. All railings must be able to withstand a 250 lb. force anywhere and in any direction along the top of the rail from within the parklet. When using a horizontal cable rail or similar flexible design, the barrier shall have a solid cap rail at the top of the barrier, and a solid curb or barrier that is a minimum of 5" high at the bottom of the barrier to provide a warning to people who are blind or have low vision. Where a solid railing is provided at the top of the barrier, the railing must be constructed to withstand the forces of people leaning or sitting on it without structural failure. Top rail assemblies shall be designed to resist a load of 50 plf (0.73kN/m) applied in any direction at the top and to transfer this load through the supports to the structure.*
- *Other means for achieving this Positive Edge can include raised planters no less than 17 inches high and 12 inches deep, built-in seating or other built-in furnishings no less than 17 inches high and no less than 12 inches deep, dense plantings that visually enclose the space and discourage pass through, bicycle parking arrangements that act to provide a Positive Edge, or some other such similar means. In some instances, such as residential streets, alleys, shared public ways or other non-arterial streets, other barriers may be considered on a case-by-case basis.*
- *At other areas, for example where the edge is perpendicular to the vehicle traffic lane, where any portion of the Deck Surface's perimeter is ½" or more above the street, curb, or sidewalk level, the edge shall be positively marked by a vertical element or barrier that is 17 inches minimum in height. These vertical elements shall have visual contrast with the Deck Surface material: either light on dark or dark on light.*

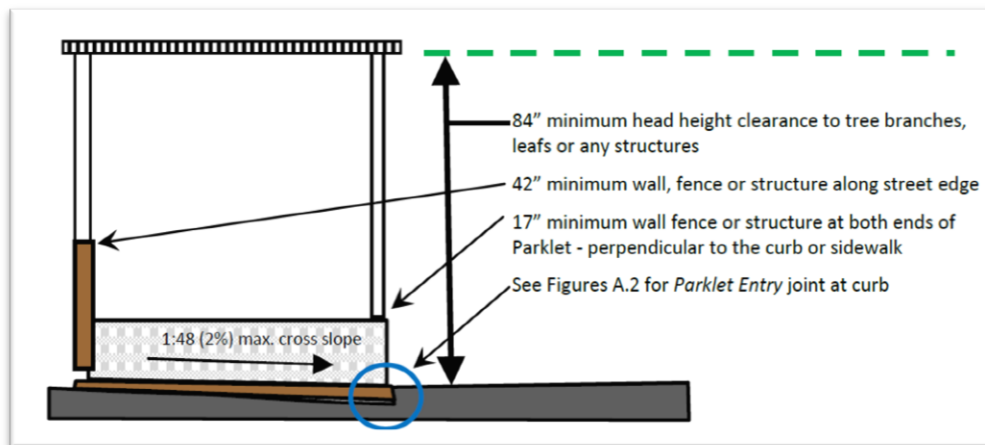

- *On streets of 30 mph or greater, streets with four or more auto lanes, or when parklets are installed along a city truck route, or Light Rail, the parklet edge of deck may necessitate a design intervention that exceeds the minimal thresholds cited above.*
- *In instances where a parklet houses bike-racks, gardens, or other such spaces where people are unlikely to linger, the elements described may not be needed. This and other unique conditions will be determined on a case by case basis.*



# Amenities

**Integrate amenities into the parklet structure:** *Parklets should include some permanent seating integrated into the parklet structure. This is to ensure that when moveable furniture like tables and seating are taken inside at night, the parklet still feels welcoming. In some instances, the City may consider other amenities like bike racks or landscaped areas to provide this function.*

**Diversity of form leads to diversity of use:** *A diversity of form helps to ensure that your parklet design will be accessible and comfortable for a wide variety of users. The creative integration of seating elements into a parklet structure can take many forms including traditional eating, railings designed for leaning, narrow benches, single-seat benches, and seating steps. Where camping is a concern, seating can be designed so it is difficult to sleep on.*

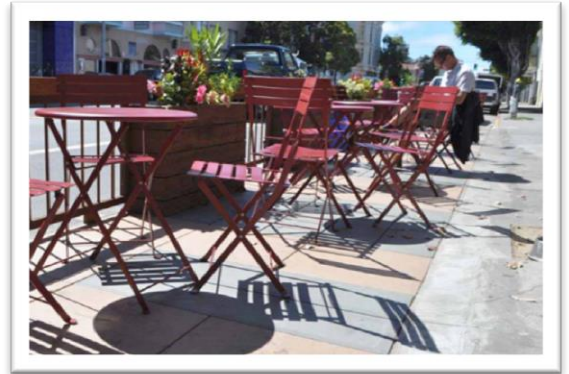

**Movable seating:** *The City strongly encourages benches and seating to be integrated into the parklet structure.*

**Planting:** *Integrated planting is strongly encouraged. Native plants, plants that provide habitat, and drought-tolerant plants are encouraged.*



**Lighting:** *Lighting elements are permitted, but may require a separate electrical permit. Applicants interested in lighting should consider solar-powered lighting to avoid the time and expense involved in running electricity from an adjacent building. We strongly encourage an illuminated parklet either from adjacent building lights or from street lighting that already exists. After businesses are closed for the evening within the proximity of the parklet it is **not** advised to leave the parklet without being illuminated. Refrain from adding electrical sockets on the parklet. If you plan adding an electrical socket make sure it is not accessible by the public.*

**Garbage Can:** *As part of the Encroachment permit you are encouraged to consider a garbage can and recycling can to be located close to your parklet so customers have a place to dispose of trash while visiting. If you are located in a “Business Improvement District” you can check if they have a program in place for garbage cans and removal of garbage.*



# Bicycle Parking



**Incorporating bicycle parking:** *Bike racks can be integrated into the parklet structure or installed adjacent to the parklet as a bike corral on the street. Bicycle parking can be incorporated into the parklet design in the following ways:*

- *On the parklet platform. Applicants may wish to install bicycle parking on top of the parklet platform, such as a custom made bicycle rack incorporated into the design of the parklet. We ask that no more than 10 % of the parklet design incorporates bike parking on the actual parklet (this does not include any bike racks that are installed on the sidewalk or in an adjacent bike corrals that might be already installed or plan to be installed).*
- *The Bike parking will need to be secure, functional, and consistent with the recommendations in the Bike Parking Guidelines, 2nd Edition, published by the Association of Pedestrian and Bicycle Professionals (ABPB). If you have questions please feel free to contact our pedestrian and bicycle coordinator (916)808-8434 or [ecox@cityofsacramento.org](mailto:ecox@cityofsacramento.org).*



- *On-street (adjacent to the parklet). The City of Sacramento could conceivably install a bike corral adjacent to a parklet under a separate application process.*

*More information can be found at:*

<http://www.cityofsacramento.org/transportation/parking/bike-rack.html>

- *If you plan on incorporating a City of Sacramento bike corral into your parklet design, you should leave a minimum of 15 feet of roadway space adjacent to the parklet for the bike corral*



# Sustainable Design & Construction

*Parklets are intended to be aesthetic improvements to the streetscape. We ask that you design them with this in mind, ensuring that the materials you use are high quality, durable, and beautiful.*

**Locally sourced materials:** *Sourcing locally produced materials for your parklet supports our local economy and reduces the imbedded carbon footprint of the final structure by reducing transportation costs.*

**Recycled and reclaimed materials:** *Choosing recycled and reclaimed materials for your parklet can reduce construction costs and keeps materials out of landfills.*



**Materials that are easy to maintain:** *Have a strategy for removing graffiti, and replacing or repairing damaged parklet features such as plants, railings, or other elements. Whereas some materials may cost more initially, they may ultimately save money in maintenance costs. For example, aluminum costs roughly three times as much as steel but when tagged, it can simply be cleaned with acetone. Project sponsors are ultimately responsible for making sure that their parklet is kept clean and in good repair.*



# Final Construction Document Package

## Construction Document:

*Parklet designers are strongly advised to communicate with City of Sacramento Encroachment Staff during the design development phase. Your assigned City Staff Member can help flag potential design concerns early on, and foresee issues raised by Public Works later in the process. This reduces the likelihood that you will have to revise the construction documents, potentially saving time and money.*

*At the end of the design process, you will need to submit a complete construction document set. This is a collection of drawings that explain how your parklet will look, what materials it will be made of, and how it will be assembled. The City prefers pdf documents in tabloid (17 x 11”) format.*

*We expect the parklet to be constructed with the materials and forms depicted in the final construction drawing set. Substitute materials must be of equal quality to the original material proposed. If you are unsure if the replacement material meets this threshold, contact City of Sacramento Encroachment Staff.*

**1. Parklet Location and Context Plan:** *This drawing shows the parklet footprint in relation to the surrounding streetscape context. It should include:*

- Your building, adjacent properties (include addresses) and their building entrances.*
- Existing sidewalk width(s).*
- Existing curb cuts and/or driveways.*
- Adjacent bike lane or auto traffic lane.*
- Existing parking spaces with dimensions.*
- Existing parking meters, with numbers of all meters to be removed (these numbers are generally posted on the meter facing the street, and are formatted as follows: PKGSXXXXX).*
- Other existing sidewalk features near the proposed parklet area (fire hydrants, streetlights, utility access panels, bike racks, etc.).*
- Existing utilities in the street, on the sidewalk, covered by or adjacent to the proposed parklet.*
- All colored curb zones (red, yellow, green, white, blue).*
- Existing street trees and tree pits.*
- Proposed parklet footprint and dimensions, including setback dimensions (48 inches from adjacent parking spaces and 12 inches from adjacent bike or auto traffic lane).*

## 2. Accessibility Plan:

- Spot elevations on the sidewalk and street.*
- Wheel chair turnaround space (see “Accessibility Elements for Parklets”).*
- Wheel chair path and rest area (see “Accessibility Elements for Parklets”).*



**3. Detail Site Plan:** This top-view drawing of your parklet design should include:

- Various elements included in the design.
- Different materials to be used in the design.
- Plant types and/or species to be used.
- Dimensions of parklet and parklet elements (including buffer areas).

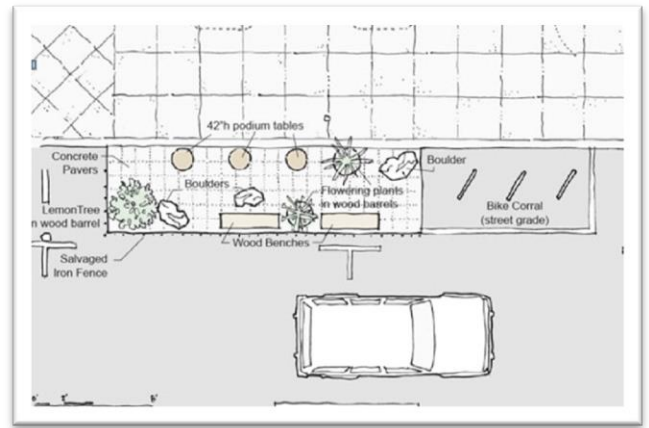

**4. Elevations from all sides:** These side-view drawings of your proposed design should include:

- Various elements included in the design.
- Different materials to be used in the design.
- Dimensions of parklet, parklet elements and buffer areas.

**5. Sections.** These are “cut-through” drawings of your parklet design that articulate complex design elements; such as how accessibility is provided.



**6. Construction Details:**

These drawings show how your parklet will be assembled or constructed. They should include:

- Any hardware such as fasteners to be used in the construction process.
- A detail showing how you will maintain positive drainage flow along the curb line. You should also articulate how you will access the drainage channel if it gets blocked.



**7. Renderings and Perspectives:**  
(optional).

# Interdepartmental Review and Approval

## Review:

Upon receiving all of the above paperwork, Department of Public Works City of Sacramento Encroachment Staff will coordinate with Traffic Engineering, Utilities, and Planning for final review. Please note that City of Sacramento Development Engineering may require additional modifications to your design, or ask for clarifications to your final document set. Adhering to the Parklet Design and Construction Guidelines, Accessibility Elements for Parklets, and making sure you've included all of the required information in your final construction document package will minimize the risk that your design will require revisions.

## Permit Issuance

After your design has been approved by all three agencies, Department of Public Works will provide you an invoice for your final permit. Revocable Permit may be revoked with or without cause at any time by the City Engineer given five (5) days written notice to permittee (per City of Sacramento Resolution 81-845 paragraph 2)

The permit fee is a one-time cost to cover City time processing the permit and removal of parking meters. The fees listed below are good faith estimate and depending on how elaborate the Parklet may be and reviews of the plans are needed additional permit fees may be collected. Permits can be renewed annually for **\$300.00** (the fee is adjusted annually for inflation).

All parklet sponsors are required to have a permit. Occupying or working within the public right-of-way without a permit can lead to fines of up to \$1,000 per day. All permits issued are subject to inspection and shall be constructed per approved plans and to City specifications

## Parklet Fee Schedule:

Revocable Permit:	\$190.00 (fee for the permit)
Removal of up to 2 Parking Meters:	\$494.00 (required only if meters currently exist)
Plan Review:	\$870.00 (Estimated fee based on internal reviews)
Encroachment Inspection:	\$400.00 (On site pre and post inspections)
<b>Total Fees</b>	<b><u>\$1954.00</u></b>

**Annual renewal of permit: \$300.00**

## Additional fees for removal of meters:

Additional base fee for each parking stall beyond the first 2: \$247.00

Depending on your location and your proposal, you may be responsible for additional permit fees, such as curb zone changes, bike corral, or sidewalk landscaping.

## Fee Payment

Please do not submit payment until you are invited to do so. The fees may be paid in person via credit card at 300 Richards Blvd Sacramento, Ca. 95811 at the public counter located on the 3<sup>rd</sup> floor or check made payable to City of Sacramento Public Works:

	<input type="checkbox"/>
<p>City of Sacramento Development Engineering 300 Richards Blvd 2nd Floor Sacramento, Ca 95811</p>	

## Step 6: Fabrication and Installation

### Required Materials:

#### No Parking Signs:

Clear the area for installation by placing temporary no-parking signs in the parking spaces that your parklet will occupy a minimum 72 hours before installation. You can purchase the signs at most hardware stores. The permittee is responsible for maintenance, upkeep, and replacement of the signs should they get removed.

#### No Smoking Signs:

Purchase at minimum two standard “No Smoking” signs for each entrance of the parklet. Most hardware stores have durable signs that can be permanently mounted. The permittee is responsible for maintenance, upkeep, and replacement of the signs should they be removed or damaged.



#### SOFT-HIT POSTS

Purchase two standardized safe-hit posts, one for each end of the parklet. The City purchases its posts at: Capital Barricade 6001 Elvas Ave. Sacramento Ca 95819 (916) 451-5176, You may purchase the posts from any vendor, but they must meet these specifications:

- Safe Hit Type 2 Guide Post 36”, White.
- Surface Mount Pin Lock Base.
- Butyl Adhesive Pad or 10 oz. Epoxy Kit.

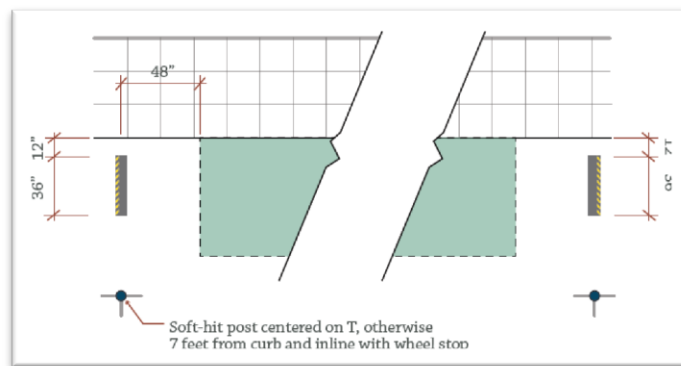

#### WHEEL STOPS

The City purchases its stops from Capital Barricade 6001 Elvas Ave. Sacramento Ca 95819 (916) 451-5176 You may purchase the stops from any vendor, but they must meet these specifications:

- Wheel stop should be 3 feet long.
- Rubber with yellow stripes.
- Mounted with bolts.
- Installed four feet from outside ends of parklet which occupies parallel parking spaces. The City will advise you on placement for parklets in diagonal or perpendicular parking spaces.
- Installed 12 inches from the curb.



#### PUBLIC PARKLET SIGNS

The applicant is required to fabricate two “Public Parklet” signs. This sign is on file at: [www.sacparklet.org](http://www.sacparklet.org). You may fabricate and purchase signs from another vendor, but you must use the design, format, and material specified by the City.

# Inspections & Installation

## PRE-INSTALLATION ON-SITE INSPECTION

Now that you've received your permit, it's time to install your parklet. You or your contractor are required to notify Department of Public Works Development Engineering at least 10 days before beginning any site work to schedule a pre-installation on-site inspection. The Department of Public Works inspector will need to review your permit paperwork before she or he can authorize you to begin construction so be sure to remember to bring a copy to the meeting. The purpose of this meeting is to post signage if required, confirm permit requirements, establish time frames for additional inspections, and review sidewalk and roadway conditions to ensure safety in the parklet area. Call 916-808-6810 or email [www.encroachments@cityofsacramento.org](mailto:www.encroachments@cityofsacramento.org) to schedule the meeting.



## INSTALLATION

Once you've received your permit and completed your pre-installation on-site inspection meeting and assembled all of your materials, you may begin constructing and installing your parklet. On-site construction and installation should be completed within 30 days. Remember to keep your worksite clean and make sure the sidewalk adjacent to your parklet installation remains unobstructed and accessible to all pedestrians.

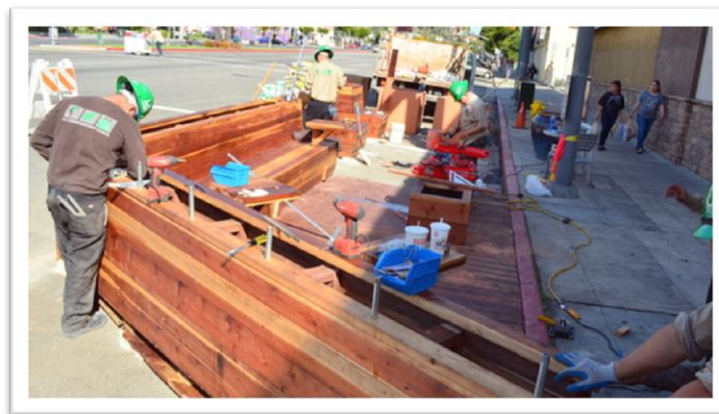

## POST-CONSTRUCTION ON-SITE INSPECTION

You or your contractor are required to notify Department of Public Works Encroachment Staff require that within five days of the end of parklet construction to schedule a Post-Construction On-site Inspection. This inspection will verify that the parklet was built to reflect the features, dimensions, and materials specified in your final Construction Documentation. Call 916-808-6810 or email [www.encroachments@cityofsacramento.org](mailto:www.encroachments@cityofsacramento.org) to schedule the meeting.





## **Step 7: Post-Construction**

### **Sponsor's Responsibilities:**

#### **Reminder: Parklets are public**

*Parklets are free and open to all members of the public to use, regardless of whether or not they patronize your business. For example, a restaurant employee is not allowed to ask someone to leave a parklet to make space for customers who wish to sit there. Table service is also prohibited at parklets; as is the placement of condiments or napkins. If your business is a restaurant or café, your customers will need to pick up their food and beverages inside at the counter rather than have your wait-staff serve them in the parklet. You are allowed to bus tables in the parklet to ensure it remains clean and well maintained.*

#### **Upkeep and maintenance**

*You are required to keep your parklet well maintained and in good repair under the conditions of approval of your permit. Parklet sponsors are encouraged to develop a maintenance plan for keeping the parklet free of debris, grime, and graffiti, and to keep all plants in good health.*

*Parklet sponsors are also required to sweep the area surrounding the parklet and keep it litter-free because City street sweepers are unable to reach the curb-line immediately adjacent to your parklet.*

*You must rinse out the area beneath the parklet at least once a week.*

*Parklets that have been installed for several years will likely require more significant renovations from time to time due to wear and tear from daily use and prolonged exposure to the elements*

#### **Permit Renewal**

*The fee to renew a parklet permit is set in the Department Of Public Works Fee Schedule, and may be adjusted annually to account for inflation. Department of Public Works renews parklet permits 12 months from when it was issued. See the Fee Schedule available for Parklets at <http://www.sacparklet.org>*

*Remember to make sure your insurance is up to date when you renew your permit.*

*If significant public concern is expressed about the installation or stewardship of your parklet, Department of Public Works may conduct an investigation and inspect the location to determine if your parklet permit should be renewed.*

## **(IV) Change of ownership:**

*If your business changes ownership you will either need to remove your parklet (see “Removal” below) or transfer the permit to the new owner. Contact Department of Public Works at: (916) 808-6810 or email [www.encroachments@cityofsacramento.org](mailto:www.encroachments@cityofsacramento.org).*

### **Removal**

**Self-initiated removal.** *If for some reason you decide you no longer want to keep your parklet, you are responsible for removing it. Removal requires an additional permit from Department of Public Works Development Engineering at: (916) 808-6810.*

**Streetscape improvements.** *As long as your parklet is kept in good repair and remains open to the public, you can renew your parklet permit indefinitely. However in some instances such as a streetscape repaving, the City may require you to remove your parklet. The City will strive to notify you as early as possible that your parklet will need to be removed. In these situations, you may need to store your parklet off-site during streetscape construction. Circumstances permitting, you may be able to re-install your parklet after the streetscape improvement has been completed.*

**Public safety emergencies.** *Because parklets may sit on top of sensitive utilities there may be instances where your parklet will need to be removed with little notice. For example, in the unlikely event of a utility failure threatening public safety such as a gas leak, the City may remove your parklet with little or no notice.*

### **Reporting for impact studies and other analysis**

*We anticipate the Sacramento Parklet Program to become a growing trend and more street space could convert to public space. The City’s nascent Parklet Program strives to incrementally transform the City’s streets and commercial districts to make them more welcoming and enjoyable for all.*

*The City is interested in better understanding and documenting the economic and social effects that parklets may have on our streets, businesses, and commercial districts. You may be asked to respond to City-issued surveys which report information that will assist with assessments and studies of the Parklet Program. Your participation in these efforts is greatly appreciated, and will help to inform others about the effects of these one-of-a-kind installations.*

## (V) Accessibility Elements



The City of Sacramento seeks to make its public spaces accessible to and usable by individuals with disabilities. This goal extends to parklets, which become an extension of public sidewalks and pedestrian open space. All accessibility elements of the proposed parklet shall be designed, constructed and/or conform to the applicable provisions, rules, regulations and guidelines of the: California Building Standards Codes, Sacramento City Codes, and Americans with Disabilities Act 2010 Standard's accessibility requirements.

### Required Accessibility Features

The following accessibility features shall be provided for each parklet:

**Parklet Path:** A Parklet Path is an accessible route that connects the sidewalk to the Parklet Entry, Deck Surface, Wheelchair Turning Space and Wheelchair Resting Space.

The Parklet Path shall be 72" wide minimum on the sidewalk and not pass over tree wells. When a 72" path is technically infeasible, then 60" may be allowed, but under no circumstances shall the path be less than 48" wide minimum. Once on the parklets Deck Surface, the Parklet Path shall be 36" wide minimum.

The cross slope (measured perpendicular to the running slope) along any portion of the Path shall not exceed 1:48 (2%).

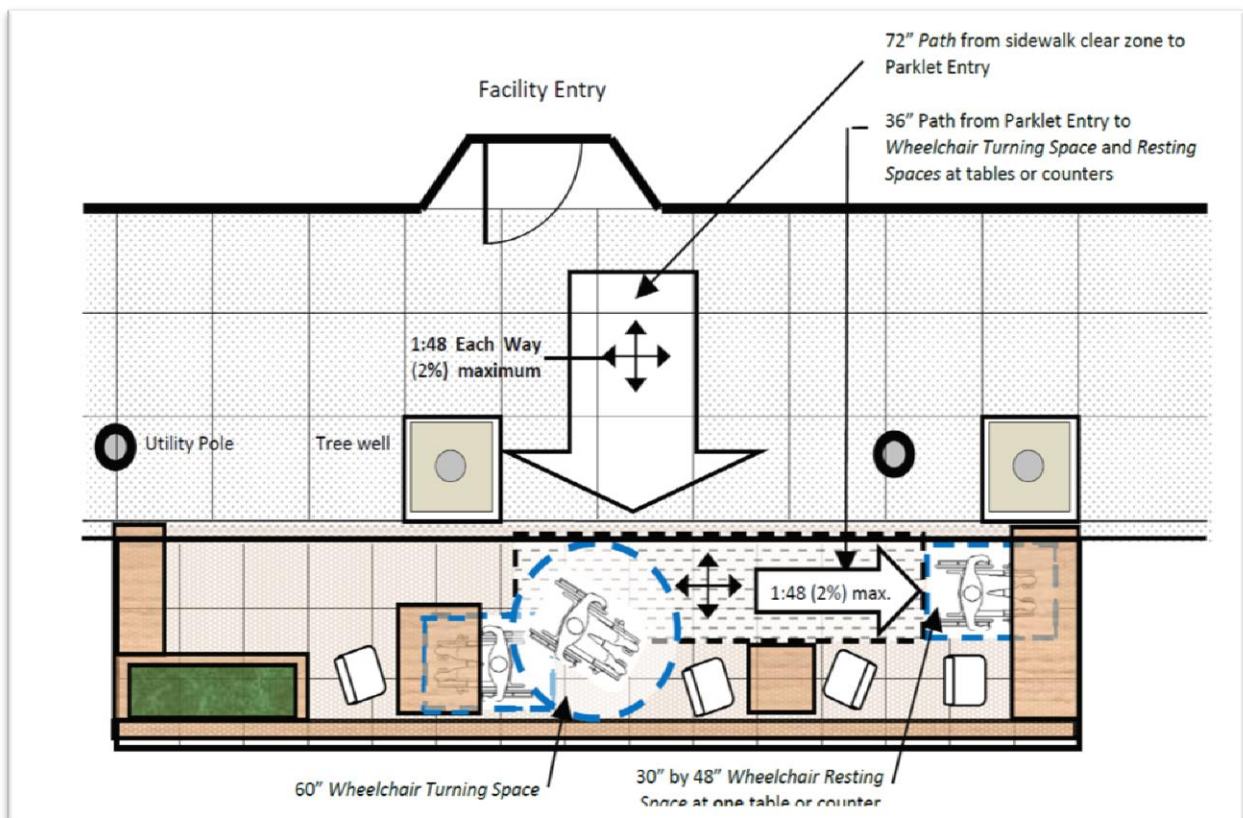

**Wheelchair Turning Space:** A Wheelchair Turning Space is an accessibility feature that is a circular area 60" minimum in diameter for use by a person with mobility aid to make a 360 degree turn (See Figure A.1 below). This space shall be located entirely within the Parklet, unless otherwise permitted. When the turning space is allowed to encroach over the sidewalk, the maximum encroachment shall be 12" unless otherwise permitted on a case by case basis. Within this space there shall be no cross slope in any direction that is greater than 1:48 (2%). Alternatively a "T" shaped Turning Space is permitted in accordance with Figure A.2 below.

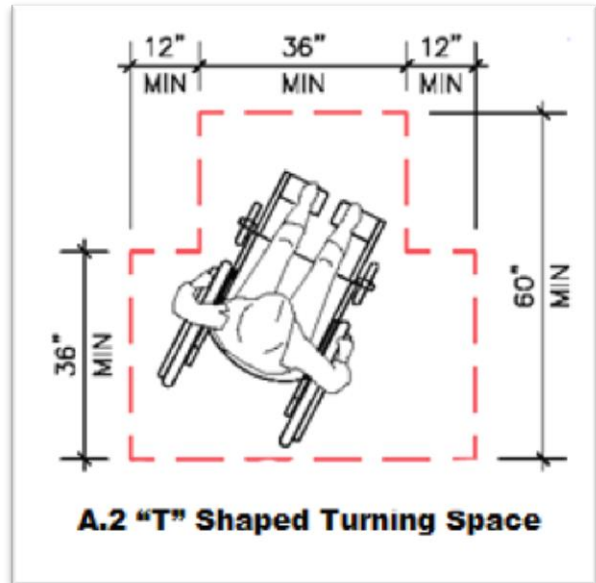
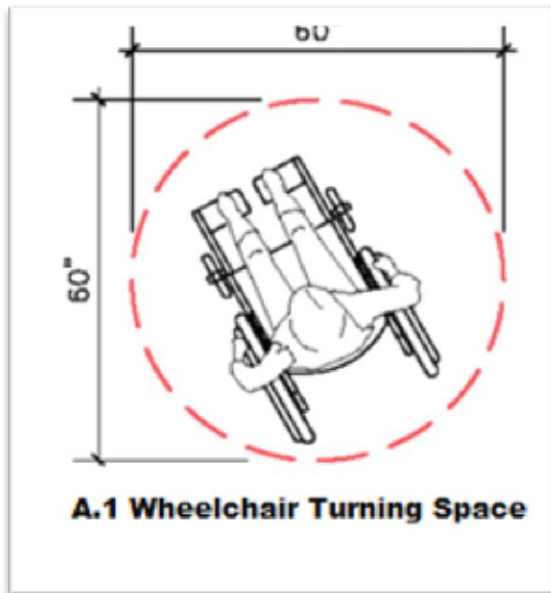

**Head Height Clearance:** An 84" minimum head height clearance is required for the Parklet Path, Parklet Entry, and Wheelchair Turning Space. With the exception of knee clearance at tables and counters, horizontal protrusions are not permitted at Wheelchair Resting Spaces.

**Wheelchair Resting Space:** A Wheelchair Resting Space has a 30" wide by 48" deep clear floor area. Within this space, there shall be no cross slope in any direction that is greater than 1:48 (2%). The Wheelchair Resting Space is permitted to overlap the Wheelchair Turning Space by 24" maximum in any orientation to one another.



## **Tables, Counters and Drink Rails and Benches:**

Where tables, counters, drink rails, or benches are provided, at least one of each feature shall be accessible.

- The height of wheelchair accessible tables, counters and or drink rails shall be 28" to 34" above the Deck Surface or ground. A Wheelchair Resting Area shall be provided adjacent to the accessible tables, counters and drink rails, and the Wheelchair Resting Area shall be accessible by a Parklet Path and a Wheelchair Turning Space.
- Wheelchair accessible tables, counters, or drink rails shall be approachable from the front and provide an unobstructed knee clearance that is at least 27" high, 30" wide and 19" deep.
- A minimum of 36" clearance shall be provided between the edge of a table and another vertical obstruction, so that a wheelchair user can maneuver into the knee space.
- Where fixed counters are provided, a 60" long portion of a fixed counter shall provide the unobstructed knee clearance of at least 27" high, 30" wide and 19" deep.
- Where drink rails are provided, a 60" long portion of a drink rail shall have 36" wide and level space adjacent to it for a side-approach by a wheelchair user.
- At fixed benches, a Wheelchair Resting Space shall be provided for a shoulder alignment adjacent to one side of the bench.

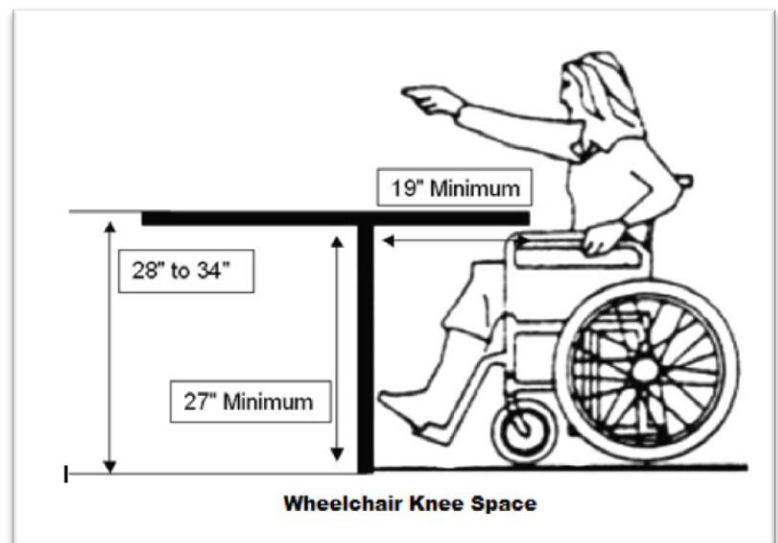

**Sidewalk Condition and Maintenance:** The sidewalk abutting the Parklet shall be in a state of good repair and maintenance.

- Sidewalks which are not in good repair may need replacement. Sidewalk maintenance is the responsibility of the property owner.
- The sidewalk abutting the parklet shall have a grade of no more than 5% running slope at the Parklet Entry. Running slope is the slope measured along the length of a sidewalk, parallel to the street.
- Tree well areas shall be filled level to the sidewalk surface.
- Sidewalk flags or cracks shall not exceed 1/2" in vertical change of elevation or in horizontal separation. Vertical changes between 1/4" and 1/2" high shall be beveled.

**Parklet Entry:** The Parklet Entry is where the Parklet Path joins the parklets Deck Surface. An ideal Parklet Entry should be located in an unobstructed area where there is the least amount of running slope along the sidewalk and curb.

- Where the Deck Surface edge abuts existing driveways or curb ramps, the driveway area or curb ramp shall be temporarily filled-in for the duration of the parklets installation.
- Any openings between the sidewalk and the Deck Surface shall be flush without a horizontal or vertical separation that would allow the passage of a ½" sphere.
- Where the curb or a portion of the curb is damaged, has settled lower than the deck surface, or has a separation greater than ½", a continuous threshold unit shall span from the deck to the sidewalk surface over the curb. Changes in level from the threshold's top surface material and the deck or the sidewalk shall not exceed ½" maximum. Changes in level of ¼" high maximum shall be permitted to be vertical, and changes in level between ¼" and ½" shall be beveled with a slope not steeper than 1:2.

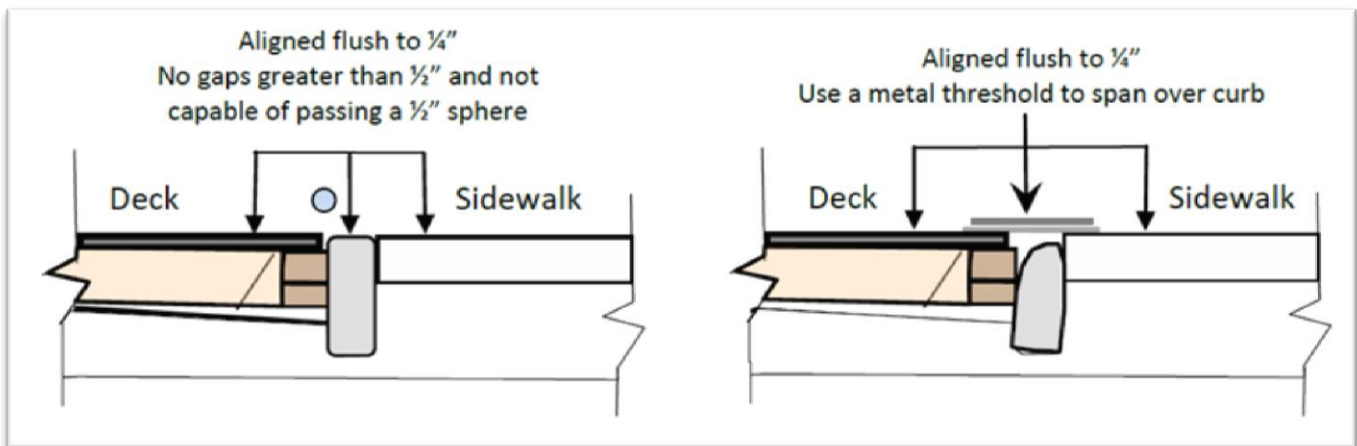

**Deck Surface:** The Parklets Deck Surface shall be firm, stable and slip resistant.

- The Deck Surface's maximum cross slope shall be no greater than 1:48 (2%) measured perpendicular to the sidewalk or curb. The parklets underlying frame or structure may need to be tapered or shimmed in order to accommodate the slope of the crown and the gutter in the street.
- The Deck Surface's maximum running slope (parallel to the curb) is 1:48 (2%) for the Wheelchair Turning Space, the Wheelchair Resting Space and the routes that connect them. The Deck Surface materials shall be installed with no gaps between them larger than would permit the passage of a ½" sphere. Elongated openings shall be placed so that the long dimensions are perpendicular to the dominant direction of travel.
- The Deck Surface shall have no abrupt changes in level exceeding ½" along the Parklet Path. No changes in level (even if they are less than ½") are recommended at either the Wheelchair Turning Spaces or Resting Spaces.
- The Deck Surface shall all be on one level unless the change in level is served by a ramp, additional Parklet Entries, or otherwise permitted on a case by case basis. When stairs or ramps are permitted, they must meet all building code requirements for rise, run, width, handrails, and contrasting stair striping for the visually impaired.

# (VI) Sacramento Parklet Application Instructions

## Application Checklist:

1. **Initial Application Form.** Use these instructions and the worksheet found at the end of this document to help you prepare for the online application form.
2. **Existing Conditions Photos.** Please submit photos of the location where you would like to install the parklet, including the parking spaces, the sidewalk, and building facade in front of the proposed location. Please consult the “Parklet Design and Construction Guidelines” for required photo perspectives. Please submit .jpg files.
3. **Initial site plan.** Please provide a measured drawing that shows the footprint of the proposed parklet installation. This initial site plan can be hand-drawn; a designer is not needed at this stage. Please consult the “Parklet Design and Construction Guidelines”, which include a sample plan and design parameters. Please submit as a pdf file
4. **Initial concept description:** A brief summary explaining your project goals and the vision for your parklet. Submit this using the online application form. Why have you chosen this location? What activities would you like to promote on the parklet? How do you anticipate the community will be involved in the creation and use of the new parklet?
5. **Proof of notification.** Documented notification from your building or property owner is required for all Initial Application Proposals.
6. **Neighborhood outreach/Petition of Support.** It is important that you involve your community in the development of your design proposal. Please submit documentation of community outreach. Please attempt to acquire signatures of support from surrounding businesses around the proposed locations. You are required to notify property owners as well as adjacent businesses. We request that you receive support from the businesses and or residents along the block face, across the street of the block face, and each of the corner properties that could be impacted by the change in parking of the proposed location of the parklet by acquiring signatures in support of the proposal. In addition it is also helpful for additional support to by:
  - Notification or letters of support from local BID or PBID. If no BID or PBID is present, letters from adjacent businesses on the block.
  - Notification or letters of support from local institutions, residents or other adjacent organizations.

### Questions?

For any questions regarding this application or the Sacramento Parklet program, please email [sacparkletprogram@cityofsacramento.org](mailto:sacparkletprogram@cityofsacramento.org).

Please include “Parklet Demo” in the subject line, and include the potential parklet address in the body of the email

### Initial Application?

Please fill out the online application and submit all the above materials on our website at: <http://www.sacparklet.org>

1. Application

# Sacramento Parklet Application Worksheet

### APPLICANT INFORMATION

Address of Proposed Parklet: \_\_\_\_\_ Zip: \_\_\_\_\_

Cross Street: \_\_\_\_\_ Fronting Parcel# \_\_\_\_\_

Councilmember District #: \_\_\_\_\_

Name Sponsoring Business/Organization: \_\_\_\_\_

Mailing Address: \_\_\_\_\_ Zip: \_\_\_\_\_

Contact Name 1: \_\_\_\_\_ Title 1: \_\_\_\_\_

Phone 1: \_\_\_\_\_ Email 1: \_\_\_\_\_

Contact Name 2: \_\_\_\_\_ Title 2: \_\_\_\_\_

Phone 2: \_\_\_\_\_ Email 2: \_\_\_\_\_

Business Certificate: \_\_\_\_\_ OR Driver's License: \_\_\_\_\_

I \_\_\_\_\_ (applicant) have read and understood the "Parklet Design and Construction Guidelines"

Name(s) of Property Owner: \_\_\_\_\_

Property Owner Address: \_\_\_\_\_ Zip: \_\_\_\_\_

Phone: \_\_\_\_\_ Email: \_\_\_\_\_

### DESIGNER INFORMATION

\_\_\_\_\_ I don't know yet \_\_\_\_\_ I'll design it myself \_\_\_\_\_ I'll hire a Designer

Designer Name (if known): \_\_\_\_\_

Design Firm (if known): \_\_\_\_\_

Phone: \_\_\_\_\_ Email: \_\_\_\_\_

### PARKING INFORMATION

Number of parking spaces to be occupied: \_\_\_\_\_ Parallel \_\_\_\_\_ Angled / Perpendicular

Meter numbers on parking meters to be removed  
\_\_\_\_\_  
\_\_\_\_\_

(found on the meter facing the street.)

Is there a colored curb(s) in your proposed location? \_\_\_\_\_ YES \_\_\_\_\_ NO

Length: \_\_\_\_\_ Red \_\_\_\_\_ Yellow \_\_\_\_\_ Blue \_\_\_\_\_ White \_\_\_\_\_ Green



# Sacramento Parklet Application Worksheet

## 2. Existing Conditions Photos

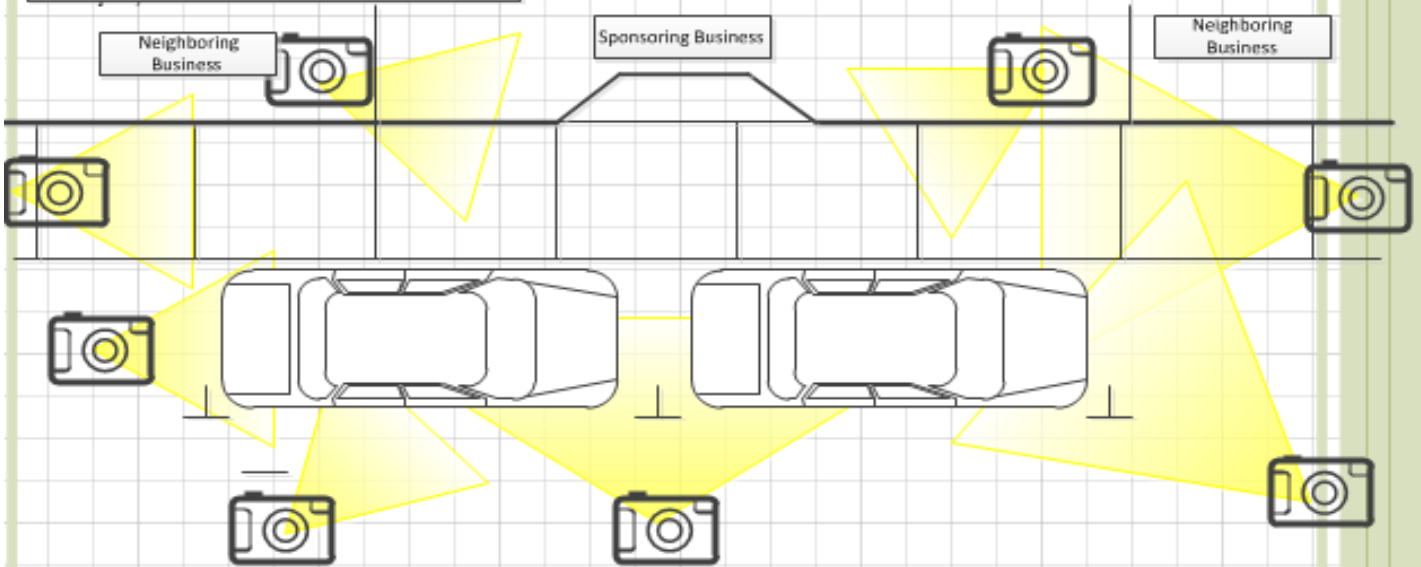

## 3. Initial Site Plan

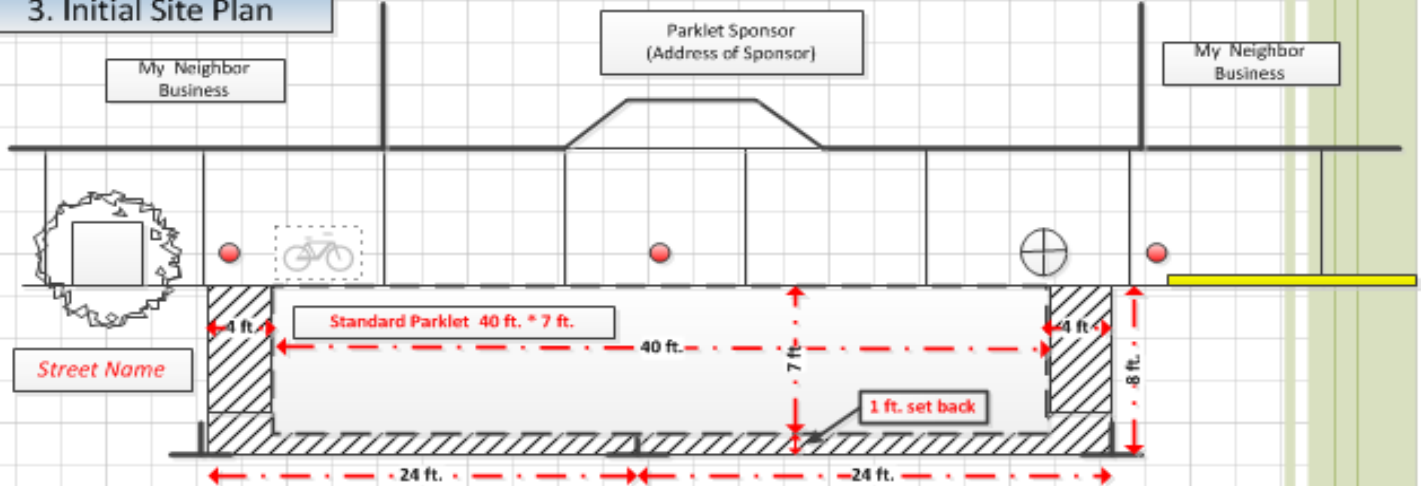

### Legend

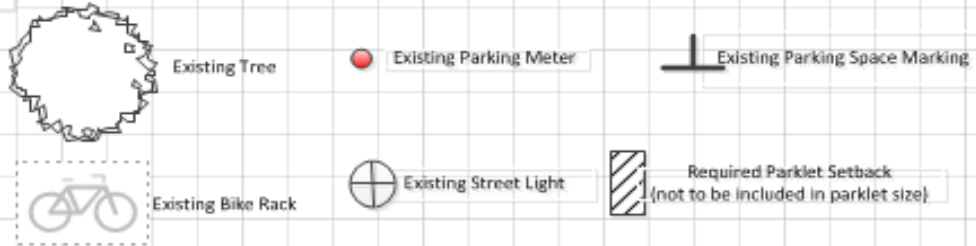

### Things to include in your site plan:

- Your building and neighboring Properties (Including addresses)
- Proposed Parklet and dimensions (don't forget to leave 4 ft buffer)
- Existing parking meters to be removed (don't forget to include meter number "PKGS#####")
- Any colored parking sidewalk features adjacent to your parklet (e.g. trees, utility access panels, bike racks, street lights. You can make up your own graphic symbols)
- Dimensions (you will probably have to measure with tape measure not all spaces are exactly 24ft.)

*Hand Drawn images are fine. You may consider using graph paper to help scale streetscape features.*

# Sacramento Parklet Application Worksheet

## 5. Sample Letter of Support



|

To whom it may concern,

I am writing to express my support for a parklet to be constructed in front of "**Business Name**" located at "**Address of Proposed Parklet**". I understand that the parklet would take the place of "**Number of spaces proposed**" parking spots. This parklet will be a great asset to the neighborhood in addition to being a space for patrons of the "**Street Name of Proposed Parklet**" businesses to congregate without blocking the sidewalk or venturing into the street.

Sincerely,

\_\_\_\_\_  
(Signature)

\_\_\_\_\_  
Name (printed)

\_\_\_\_\_  
Contact (phone or email)

\_\_\_\_\_  
Address

\_\_\_\_\_  
Date

## 6. Sample Petition of Support

"**Parklet Sponser's Name**"

"**Parklet Sponser's Address**"

I support a "Parklet" in front of "**Parklet Sponser's Name**". Thank you for sponsering the improvement of this public space on "**Street Name of Proposed Parklet**".

Signature	Name	Address	Phone	Email	Blocks of Proposed Parklet

# (VII) Parklet Final Application Instructions

Once Department of Public Works Encroachment has approved your design, you will need to complete the forms listed below before your paperwork can be routed internally and your permits can be issued.

## Submittal Application Checklist

### **1. Final Construction Document Package / Design Documents**

- Parklet Location and Context Plan. This drawing should show the parklet footprint in relation to the surrounding streetscape context.*
- Accessibility Plan. This drawing illustrates ADA access to the parklet.*
- Detail Site Plan. This is a top-view drawing of your parklet design.*
- Elevations from all sides. These are side-view drawings of your proposed design.*
- Sections. These are “cut-through” profile drawings of your parklet design.*
- Construction Details. These drawings show how your parklet will be assembled or constructed.*
- Renderings and Perspectives (optional)*

### **2. Parking Permit Application.**

*This basic Parklet Permit Application Worksheet is available on the Sacramento Parklet Program website <http://www.sacparklet.org>. You can find your block and lot numbers by typing the building address adjacent to your parklet location on the Sacramento County Assessor Parcel Viewer at <http://assessorparcelviewer.saccounty.net/GISViewer/Default.aspx>*

### **3. Revocable Permit Application Processing Instructions.**

*This is a basic “Revocable” permit application located at [http://www.cityofsacramento.org/transportation/dot\\_media/development\\_engineer/forms/general/permits/revocable-encroach-permit-package.pdf](http://www.cityofsacramento.org/transportation/dot_media/development_engineer/forms/general/permits/revocable-encroach-permit-package.pdf). While filling out the Revocable Permit Application you find that the “Sacramento Parklet Application Worksheet” has some of the same information needed for this permit if so please indicate “See Parklet Application” . Please remember to:*

- a) *Provide proof of liability insurance as directed by attached REQUIREMENTS FOR CERTIFICATES OF INSURANCE. Provide certificate of insurance and endorsement from owner with the City of Sacramento listed as certificate holder and as additional insured. List project address. For more information contact the City of Sacramento Risk Management Office at (916) 808-5556*

#### **4. Excavation Encroachment Permit Application Processing Instructions:**

*This is the basic “Encroachment” permit application located at [http://www.cityofsacramento.org/transportation/dot\\_media/development\\_engineer/forms/general/permits/street-use-excavation-encroach-permit-pkg.pdf](http://www.cityofsacramento.org/transportation/dot_media/development_engineer/forms/general/permits/street-use-excavation-encroach-permit-pkg.pdf) Although you will not be excavating anything in the right of way you will need to fill this application out. You will indicate at number “3. General Description of Work to be Done: section (c) Other” you will indicate **“Parklet”** as the Description.*

#### **5. Letters of Support and Petition of Support:**

*Public Works requires demonstrated support from adjacent property owners and businesses, PBID’s, neighborhood organizations and nearby residents. Please submit a signed petition at a minimum.*

#### **6. Proof of Insurance.**

*All parklet sponsors need to have the City of Sacramento added as an “Additionally Insured” with a minimum liability coverage of \$1,000,000. Most insurance companies will do this for little or no extra charge.*

#### **7. Parklet Host Agreement Form.**

*This confirms that you will maintain the Parklet and comply with public accessibility guidelines.*

*Please submit all the above material to the Department of Public Works. Original signed hard copies (not electronic scans) are required.*

# (VIII) Parklet Budget Worksheet (Sample)

1. Design Services:

\_\_\_\_\_  
\_\_\_\_\_

\$ \_\_\_\_\_, \_\_\_\_\_ . \_\_\_\_  
\$ \_\_\_\_\_, \_\_\_\_\_ . \_\_\_\_  
\$ \_\_\_\_\_, \_\_\_\_\_ . \_\_\_\_

2. Permits

\_\_\_\_\_  
\_\_\_\_\_  
\_\_\_\_\_  
\_\_\_\_\_  
\_\_\_\_\_

\$ \_\_\_\_\_, \_\_\_\_\_ . \_\_\_\_  
\$ \_\_\_\_\_, \_\_\_\_\_ . \_\_\_\_  
\$ \_\_\_\_\_, \_\_\_\_\_ . \_\_\_\_  
\$ \_\_\_\_\_, \_\_\_\_\_ . \_\_\_\_  
\$ \_\_\_\_\_, \_\_\_\_\_ . \_\_\_\_

3. Revocable Permit Application Processing Instructions

\$ \_\_\_\_\_, \_\_\_\_\_ . \_\_\_\_

4. Possible Curb Color Changes

\$ \_\_\_\_\_, \_\_\_\_\_ . \_\_\_\_

5. Required Materials

\_\_\_\_\_  
\_\_\_\_\_  
\_\_\_\_\_  
\_\_\_\_\_  
\_\_\_\_\_

\$ \_\_\_\_\_, \_\_\_\_\_ . \_\_\_\_  
\$ \_\_\_\_\_, \_\_\_\_\_ . \_\_\_\_  
\$ \_\_\_\_\_, \_\_\_\_\_ . \_\_\_\_  
\$ \_\_\_\_\_, \_\_\_\_\_ . \_\_\_\_  
\$ \_\_\_\_\_, \_\_\_\_\_ . \_\_\_\_

6. All Other Materials

\_\_\_\_\_  
\_\_\_\_\_  
\_\_\_\_\_  
\_\_\_\_\_  
\_\_\_\_\_

\$ \_\_\_\_\_, \_\_\_\_\_ . \_\_\_\_  
\$ \_\_\_\_\_, \_\_\_\_\_ . \_\_\_\_  
\$ \_\_\_\_\_, \_\_\_\_\_ . \_\_\_\_  
\$ \_\_\_\_\_, \_\_\_\_\_ . \_\_\_\_  
\$ \_\_\_\_\_, \_\_\_\_\_ . \_\_\_\_

7. Fabrication/Installation:

\_\_\_\_\_  
\_\_\_\_\_  
\_\_\_\_\_  
\_\_\_\_\_  
\_\_\_\_\_

\$ \_\_\_\_\_, \_\_\_\_\_ . \_\_\_\_  
\$ \_\_\_\_\_, \_\_\_\_\_ . \_\_\_\_  
\$ \_\_\_\_\_, \_\_\_\_\_ . \_\_\_\_  
\$ \_\_\_\_\_, \_\_\_\_\_ . \_\_\_\_  
\$ \_\_\_\_\_, \_\_\_\_\_ . \_\_\_\_

# **(IX) Parklet Sponsor Agreement Form**

## **PARKLETS ARE PUBLIC**

*I agree to keep my parklet free and open to all members of the public, regardless of whether or not they patronize my business. I will not provide table service at my parklet, nor will I place condiments or napkins on the parklet tables. My customers will pick-up their food and beverages inside at the counter. I will bus tables in the parklet to ensure it remains clean and well maintained.*

## **UPKEEP, MAINTENANCE & INSURANCE**

*I agree to keep my parklet well maintained and in good repair under the conditions of approval of my Department of Public Works permit. I will keep the parklet free of debris, grime, and graffiti, and to keep all plants in good health.*

*I agree to sweep the area surrounding the parklet and keep it litter-free. I agree to clear out the area beneath the parklet at least once a week.*

*I understand that my insurance must be kept up to date in order to renew my parklet permits.*

## **PERMIT RENEWALS, CHANGE OF OWNERSHIP & REMOVALS**

*I understand that parklet permit is renewable on an annual basis at the discretion of City staff.*

*I understand that if my business changes ownership, I will either need to remove my parklet or transfer the permit to the new owner. I understand that if for some reason I no longer want my parklet, I am responsible for removing it.*

*I understand that in some instances such as a streetscape repaving, the City may require me to remove the parklet. In these situations, I may need to store my parklet off-site. I may be able to re-install my parklet after the streetscape improvement has been completed.*

*I understand that because parklets may sit on top of sensitive utilities there may be instances where my parklet will need to be removed with little notice. The City may remove my parklet with little or no notice.*

## **REPORTING FOR IMPACT STUDIES & OTHER ANALYSIS**

*I understand that the City is interested in better understanding the social and economic impacts that parklets may have on our streets, merchants and commercial districts. I will be asked to report information that will assist the City with assessments and studies of the Parklet Program.*

Signature: \_\_\_\_\_

Date: \_\_\_\_\_

Name: \_\_\_\_\_

Parklet Address: \_\_\_\_\_

# **(X) Supporters and Outreach:**

## **Sacramento Area Bicycle Advocacy “SABA”**

Jim Brown, Executive Director

## **Sacramento Metropolitan Air Quality Management District “SMAQMD”**

Tim Taylor , Division Manager, Land Use, Communications and Mobile Sources

Freya Arick, Air Quality Planner/Analyst

Larry Robinson, SMAQMD Program Coordinator/Association for Commuter Transportation

Joseph J. Hurley, Assistant Air Quality Analyst

## **WALKS Sacramento**

Teri Duarte, Executive Director

## **Handle District**

Seann Rooney, Executive Director

## **Midtown Business Association “MBA”**

Emily Baime Executive Director

Melinda Pederson, Operation Coordinator

## **Downtown Partnership**

Dion Dwyer, Community Service Director

## **City of Sacramento Staff**

Howard Chan, Assistant City Manager

Jerry Way, Director of Public Works

Matt Eierman, Parking Manager, Public Works

Hector Barron, Traffic Engineer, Public Works

John Perez, Traffic Investigator , Public Works

Staci Hovermale, Administrative Technician , Public Works

Ronald Fong, Senior Engineer, Public Works

Cesar Narvaez, Assistant Civil Engineer, Public Works

Neil Albritton, City of Sacramento ADA Coordinator,

Greg Taylor, Urban Design Manager, Community Development Department

Luis Sanchez, Senior Architect, Community Development Department

Ryan DeVore, Chief Building Official, Community Development Department

Jameson Parker, Constituent Services Liaison, Councilmember Steve Hansen District 4



*On behalf of the City of Sacramento's Public Works Department we want to thank you for your interest in the Sacramento Parklet Program. We look forward to working together with you on each step of the process and making sure you have a successful parklet.*